



Systems and Components for Roof Landscapes

Product List

Life on Roofs



Table of Contents

<i>Slip Sheet and Separation Membrane</i>	3
<i>Root Barriers</i>	4
<i>Root Barriers Accessories</i>	5
<i>Protection Mats</i>	6
<i>Drainage Elements</i>	8
<i>Building Protection and Drainage Elements</i>	12
<i>Filter Sheets</i>	14
<i>Mineral Substrates / Delivery Forms</i>	15
<i>System Substrates</i>	16
<i>Substrates in Bags / Fertilizer</i>	17
<i>Seed Mixtures / Roof Tree Anchorage Robafix®</i>	18
<i>Pitched and Steep Pitched Green Roofs</i>	19
<i>Shear Protection Accessories</i>	20
<i>System Build-ups with Aquafleece® AF 300</i>	21
<i>System Build-up "Roof Garden" with Aquatec® AT 45</i>	22
<i>System Build-up "Stormwater Management Roof"</i>	23
<i>Inspection Chambers</i>	24
<i>Dam-up Irrigation</i>	26
<i>Drainage Channels</i>	27
<i>Balcony and Terrace Channel</i>	28
<i>Terrace Grills</i>	29
<i>Separations</i>	30
<i>Eaves Profiles</i>	30
<i>Gravel Retainers</i>	32
<i>Clamping and Protection Profiles</i>	33
<i>Fall Protection Fallnet®</i>	34
<i>Guardrail Solutions</i>	36
<i>Vertically Adjustable Pedestals Elefeet®</i>	38
<i>Elefeet® Support Rail System</i>	39
<i>Elefeet® Support Rail Accessories</i>	39
<i>Pedestals Accessories</i>	41
<i>Slab Pavements Accessories</i>	42
<i>Photovoltaics and Green Roofs</i>	43
<i>PV Subconstruction Accessories</i>	45
<i>Why have a Green Roof?</i>	46
<i>Types of Green Roofs</i>	47
<i>European Technical Assessment</i>	48
<i>The Roofs of the Future are Green</i>	49

Components for Green Roof Systems

Page 3



Drainage Channels, Balcony and Terrace Channels, Terrace Grills

Page 27



Separations, Eaves Profiles, Clamping and Protection Profiles

Page 30



Fall Protection and Guardrail Solutions

Page 34



Vertically Adjustable Pedestals

Page 38



Photovoltaics and Green Roofs

Page 43



Slip Sheet and Separation Membrane

Separation and slip sheets, as loosely laid tarps or sheets, protect the waterproofing from tensile and shear forces. In the case of chemically incompatible materials (e.g. single soft PVC sheets on bitumen), a neutral separation layer has to be installed. Only vapour permeable membranes (e.g. TGV 21), and no vapour barriers, should be used over an XPS insulation in inverted roof constructions, in order to avoid condensation within the insulation.

Slip Sheet TGF 20



Chemically neutral high-pressure-polyethylene sheet for application as separation and slip sheet on green roofs, for walkways and driveways; compatible with bitumen and polystyrene; resistant to most chemicals; UV-stabilized; smooth surface; vapour barrier ($S_d \geq 100$ m); colour: black; thickness: ca. 0.20 mm; weight: ca. 190 g/m².

	Art.-No.	Dimensions	Unit	Pallet
TGF 20	1020	ca. 8.00 m × 25.00 m	200 m ² roll	4600 m ²
	1022	ca. 3.00 m × 33.50 m	100.5 m ² roll	2412 m ²

Separation Membrane TGV 21 (Diffusion Membrane)



Air and vapour permeable membrane; water-repellent; thermally bound; made of 100 % polypropylene; can be used as a separation layer and as protection against **small particle infiltration**, e.g. on inverted green roofs, as metal protection against harmful effects of adjoining materials, etc. Chemically and biologically neutral; compatible with bitumen and polystyrene; resistant to acids and alkalis; permeable to vapour ($S_d < 0.01$ m); colour: black; thickness: ca. 0.55 mm; weight: ca. 80 g/m².

	Art.-No.	Dimensions	Unit	Pallet
TGV 21	2180	ca. 1.60 m × 250.00 m	400 m ² roll	3600 m ²
	2185	ca. 1.60 m × 50.00 m	80 m ² roll	2400 m ²

Root Barriers

Root barriers, as loosely laid tarps or welded sheets, protect the waterproofing from root penetration. This protection is mainly necessary for bituminous waterproofings. The hot-air-weldable Root Barrier WSB 100-PO is used on complicated roof areas with many upstands, penetrations, etc. and on intensive green roofs. Large-size tarps of Root Barrier WSF 40 made of special polyethylene, laid with 1.5 m overlap, are suitable for simple extensive green roof areas. In general the material compatibility of the root barrier and the waterproofing has to be taken into account. ZinCo Root Barriers WSF 40 and WSB 100-PO are compatible with bitumen.

Root Barrier WSF 40



High-pressure polyethylene sheet, solid and with high tensile strength, for application as loosely laid root barrier mainly on extensive green roofs and in planters. Root proof; compatible with bitumen and polystyrene; free of plasticizer; resistant to humic acids and oil; UV-stabilized; water vapour permeability of air layer thickness according to German Standard DIN 52615: $S_d \geq 200$ m); colour: black; thickness: ca. 0.34 mm; weight: ca. 320 g/m².

	Art. No.	Dimensions	Unit	Pallet
WSF 40	1040	ca. 8.00 m × 25.00 m	200 m ² roll	2800 m ²
	1041	ca. 6.25 m × 20.00 m	125 m ² roll	2500 m ²
	1043	ca. 2.00 m × 50.00 m	100 m ² roll	3000 m ²
	1044	ca. 3.00 m × 33.50 m	100.5 m ² roll	2412 m ²
	41040	ca. 6.25 m × 3.20 m	20 m ² tarp	600 m ²

Root Barrier WSB 100-PO



Root Barrier made of flexible polyolefin (FPO); compatible with bitumen, polyester scrim reinforced; flexible at low temperatures; hot-air-weldable; tested for root and rhizome resistance in accordance with FLL testing procedures; UV-stabilized for storage purposes, however not UV resistant in the long term; light grey colour; tensile strength (both directions): 800 N/5 cm; elongation at rupture > 20 %; thickness: ca. 1.10 mm; weight: ca. 1.13 kg/m²; weight per roll: ca. 84 kg.

	Art. No.	Dimensions	Unit	Pallet
WSB 100-PO	1084	ca. 2.44 m × 30.50 m	74.40 m ² roll	1116 m ²



Details on page 48

* Please note our warranty conditions which will be sent to you upon request.

Root Barriers Accessories

Prefabricated Corner and Unsupported Flashing



Prefabricated corner made of FPO, used for Root Barrier WSB 100-PO; compatible with bitumen. Combined internal/external corner.

	Art. No.	Dimensions	Unit
Combined External (EC) and Internal (IC) Corner	1192		Piece
Unsupported Flashing	1195	ca. 0.60 m × 15.00 m weight: ca. 9 kg /roll	Roll

Clamping Profile AP 40



Clamping profile, e.g. for fixation of root barriers, or pond liners to concrete kerbs or planters, made of aluminium; predrilled holes, spacing between the holes ca. 200 mm. Profile height: ca. 40 mm.

	Art. No.	Length	Unit
AP 40	7620	ca. 3.00 m	Bundle of 10 pieces

Further Clamping profiles on page 33

Foil-Welding-Set



Complete accessory set for hot air welding of root barrier, waterproofing or pond sheets and for joint welding of PVC-sheets. Delivered in a solid aluminium case. Contains: hot-air-fan with two jets, brush bottle for solution welding compound, spray bottle for liquid foil, pressing roll, gloves, protection glasses, mouth mask, compound action tin snips, blade knife, scissors, screwdriver, ruler, funnel, operating instructions.

	Art. No.	Unit
Foil-Welding-Set	9520	Aluminium Case

System-Adhesive Tape 40



Special double sided self-adhesive tape to bond foil and sheet to bituminous surfaces, flashings, or concrete. To be used as an installation aid only, joints are not root resistant. Application temperature ca. 20°C.

	Art. No.	Width	Unit	Pack
Adhesive System Tape 40	9500	ca. 40 mm	40 m roll	120 m

Protection Mats

Protection mats protect root barriers or root-resistant waterproofing from mechanical damages (necessary according to German Standard DIN 18531 T3, e.g. extensive greening). The mats also function as water and nutrient reservoirs and reduce subsonic noise. Protection Mats TSM 32 and SSM 45 are mainly used for extensive green roofs. On intensive green roofs and under hard surfaces, the solid Protection Mat ISM 50 and the thicker Protection Mat BSM 64 are recommended.

In general, protection mats have to be installed with an overlap of at least 100 mm. The installation of a double layer increases the protection and water storage capacity.

Protection Mat TSM 32



Details on page 48

Non-rotting, synthetic fibre mat made of polyester; used as protection layer, in accordance with German Standard DIN 18531 T3, on root barrier or waterproofing of extensive green roofs; water and nutrient storage; compatible with bitumen; biologically and chemically neutral; heat-resistant; tearproof; made of recycled material. With proven protection efficiency in accordance with European Standard EN ISO 13428. Strength class 3; melting point: ca. 260 °C; water storage capacity: ca. 3 l/m²; thickness: ca. 3 mm; weight: ca. 350 g/m².

	Art. No.	Dimensions	Unit	Pallet
TSM 32	2032	ca. 2.00 m × 50.00 m	100 m ² roll	800 m ²
	42035	ca. 2.00 m × 10.00 m	folded to 1.00 × 1.00 m	500 m ²

Protection Mat Strips SM-R



Protection mat strips made of polyester fibres, to be used at roof upstands and in connecting areas. Ideal in combination with Fixodrain® XD 20. The rear side is sprayed with pressure-sensitive adhesive to ease the assembly process; compatible with bitumen, biologically and chemically neutral; thickness: ca. 3 mm; weight: ca. 320 g/m².

	Art. No.	Dimensions	Unit	Pallet
SM-R	2035	ca. 0.50 m × 25.00 m	12.5 m ² roll	250 m ²

Protection Mat SSM 45

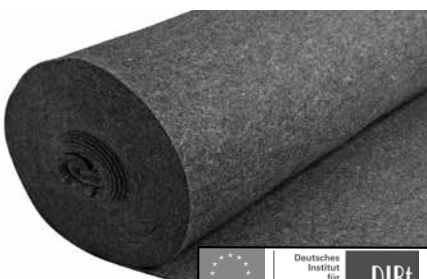

Details on page 48

High quality synthetic fibre mat made of polyester/polypropylene mixture, used as protection layer, in accordance with German Standard DIN 18531 T3, on root barrier (part of the ZinCo root barrier system "E") or waterproofing of extensive green roofs; water and nutrient storage; compatible with bitumen; biologically and chemically neutral; non-rotting; tearproof; made of recycled material. With proven protection efficiency in accordance with European Standard EN ISO 13428. CBR-Test according to European Standard EN ISO 12236: penetration resistance > 2000 N (strength class 3); strip tension test according to European Standard EN ISO 10319: tensile strength lengthwise > 5.5 kN/m; extension lengthwise > 75 %; water storage capacity: ca. 5 l/m²; thickness: ca. 5 mm; weight: ca. 470 g/m².

	Art. No.	Dimensions	Unit	Pallet
SSM 45	2045	ca. 2.00 m × 50.00 m	100 m ² roll	500 m ²
	2046	ca. 1.00 m × 10.00 m	folded to 1.00 × 1.00 m	

Protection Mats

Protection Mat BSM 64

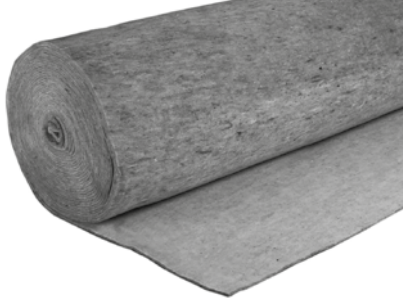

Non-rotting, synthetic fibre mat made of polyester/polypropylene mixture; used as protection layer on root barrier or waterproofing; extremely high water storage capacity; compatible with bitumen; biologically and chemically neutral; tearproof; made of recycled material. With proven protection efficiency in accordance with European Standard EN ISO 13428. Strength class 4; water storage capacity ca. 7 l/m²; thickness ca. 7 mm; weight ca. 650 g/m².

	Art. No.	Dimensions	Unit	Pallet
BSM 64	2064	ca. 2.00 m × 25.00 m	50 m ² roll	400 m ²

Protection Mat WSM 150



Non-rotting, thermally reinforced needle fleece mat made of mixed fibres; used as water storage mat on green roofs, especially on pitched roofs; extremely high water storage capacity; compatible with bitumen; biologically and chemically neutral; tearproof; made of recycled fibres; **water storage capacity ca. 12 l/m²**, thickness ca. 17 mm; weight ca. 1500 g/m².

	Art. No.	Dimensions	Unit	Pallet
WSM 150	2015	ca. 1.00 m × 15.00 m	15 m ² roll	120 m ²

Protection Mat ISM 50



Details on page 48

Non-rotting, synthetic mat made of polyester/polypropylene mixture with high mechanical durability; with bottom sided fiber bonding using acrylic dispersions and therefore easy to be glued; water and nutrient storage; used for intensive green roofs (part of the ZinCo Root Barrier System "I") and under walkways and driveways; compatible with bitumen; biologically neutral; spade-resistant; made of recycled material; reduces subsonic noise (VM: +25 dB, with gravel and concrete pavers). With proven protection efficiency in accordance with European Standard EN ISO 13428.

CBR-Test in accordance with European Standard EN ISO 12236: penetration resistance > 3500 N; strength class 5; water storage capacity ca. 4 l/m²; thickness ca. 6 mm; weight ca. 850 g/m².

	Art. No.	Dimensions	Unit	Pallet
ISM 50	2050	ca. 2.00 m × 25.00 m	50 m ² roll	400 m ²

Elastosave ES 30



Ideal protection
e.g. under Elefeet®
see page 38

High quality, extra slim protection mat made of recycled rubber, for full-surface installation onto roof waterproofing. The tensile strength of ca. 0.8 N/mm² is twice that of common chip rubber mats, and the elongation at rupture of 125 % is three times greater.

On bitumen layers the surface has to be swept clean. The ES 30 has to be installed with an overlap of 50 mm. In the case of synthetic roof waterproofing, it should be checked for rubber compatibility (generally this means the presence of bitumen-compatible tracks). If incompatible, an additional separation layer (ZinCo TGF 20) is required.

Thickness ca. 3 mm; weight ca. 2,6 kg/m²; temperature resistant from -30 °C to +80 °C.

	Art. No.	Dimensions	Unit	Pallet
Elastosave ES 30	2094	ca. 1.50 m × 8.00 m	12 m ² roll	288 m ²

Drainage Elements

The Floradrain® System has been developed especially for the landscaping of flat roofs. The molded elements of thermoformed recycled polyolefin can store rainwater in water storage cells on the upper side and drain off excess water below. The necessary aeration of the root space is ensured. Floradrain® FD 25-E is particularly suitable for extensive green roofs with a slope while Floradrain® FD 40-E is also suitable for intensive green roofs and for terraces. With Floradrain® FD 60 neo, green roofs with a water dam-up can be created on 0°-roofs. Floradrain® in rolls is ideal for use on barrel roofs. Stabilodrain® SD 30 elements have been developed with a high load-bearing capacity (e.g. for use on parking lots, driveways).

Floradrain® FD 25-E

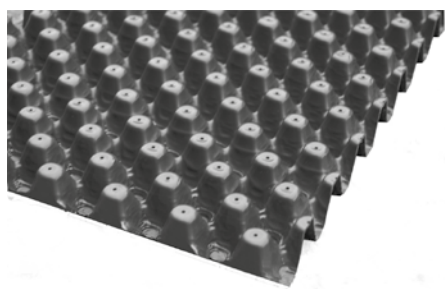

Drainage and water storage element for use under extensive and simple intensive green roofs as well as under walkways and terraces; made of thermoformed recycled polyolefin (mainly PE); waterstorage cells; openings for aeration and diffusion, with channel system on the underside. In-plane water flow rate tested according to European Standard EN ISO 12958. Compatible with bitumen and pressure resistant; butt joint installation; connection with clamps is possible. Compressive strength: ca. 270 kN/m²; filling volume: ca.10 l/m²; weight: ca. 1.6 kg/m²; height: ca. 25 mm.

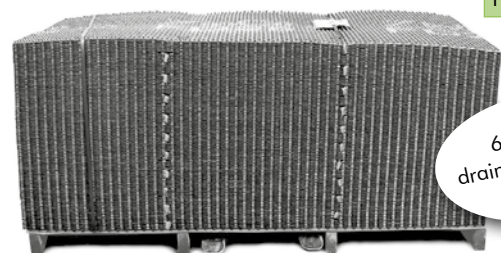

600 m² of
drainage elements
per pallet

	Art. No.	Dimensions	Unit	Pallet
FD 25-E	3028	ca. 1.00 m × 2.00 m	2.00 m ² board	600 m ²



Applies for any
Floradrain® FD 25-E products

Details on page 48

Floradrain® FD 25-R

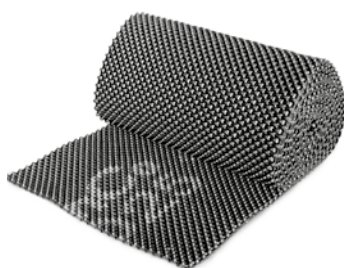

Floradrain® FD 25-R on rolls, e.g. for landscaping barrel roofs. Floradrain® FD 25-R can be applied continuously and therefore can bear the tensile forces. Standard length: 15 m; material: thermoformed recycled polyolefin (mainly PE).

	Art. No.	Dimensions	Unit	Pallet
FD 25-R (Roll)	3023	ca. 1.00 m × 15.00 m	15 m ² roll	75 m ²

Floradrain® FD 25-RV



Floradrain® FD 25-RV is available with a filter sheet attached to the upper side, for efficient green roof installation. The filter sheet overlaps by ca. 100 mm along one side. Please note the greater transport volume of the rolls compared with the boards. Material: thermoformed recycled polyolefin (mainly PE).

	Art. No.	Dimensions	Unit	Pallet
FD 25-RV (Roll & Filter Sheet)	3022	ca. 1.00 m × 15.00 m	15 m ² roll	60 m ²

Drainage Elements

Floradrain® FD 40-E

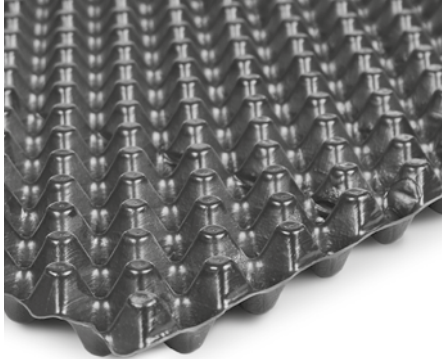

Drainage and water storage element made of thermoformed recycled polyolefin (mainly PE), with water storage cells, openings for aeration and diffusion; with channel system on the underside. In-plane water flow rate tested according to European Standard EN ISO 12958. Compatible with bitumen and pressure resistant; butt joint installation; additional connectors available; Floradrain® FD 40-E is used under extensive and simple intensive green roofs as well as under walkways and terraces, even without a slope. Compressive strength: ca. 170 kN/m²; filling volume: ca. 17 l/m²; weight: ca. 1,9 kg/m²; height: ca. 40 mm.

	Art. No.	Dimensions	Unit	Pallet
FD 40-E	3041	ca. 1.00 m x 2.00 m	2.00 m ² board	500 m ²

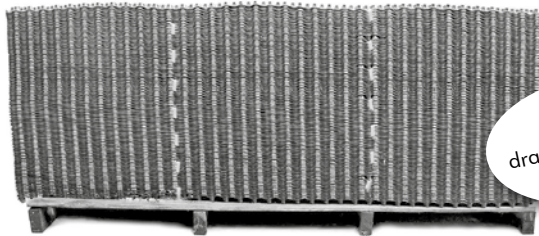

500 m² of drainage elements per pallet



Details on page 48

Applies for any Floradrain® FD 40-E products

Floradrain® FD 40-RV



Floradrain® FD 40-RV is available with a filter sheet attached to the upper side, for efficient green roof installation. The filter sheet overlaps by ca. 100 mm along one side. Please note the greater transport volume of the rolls compared with the boards. Material: thermoformed recycled polyolefin (mainly PE).

	Art. No.	Dimensions	Unit	Pallet
FD 40-RV (Roll & Filter Sheet)	3042	ca. 0.94 m x 10.70 m	10 m ² roll	30 m ²

Connectors for FD 25-E and FD 40-E

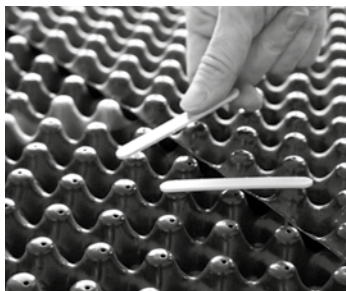

For a safe and stable connection of Floradrain® sheets; to be pressed into the diffusion openings, made of yellow plastic. Recommended quantity: ca. 2 connectors/m².

	Art. No.	Unit
Connector for FD 25-E and FD 40-E	9620	Bag of 100 pieces

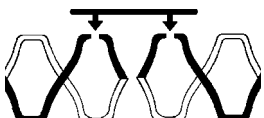

Drainage Elements

Floradrain® FD 60 neo

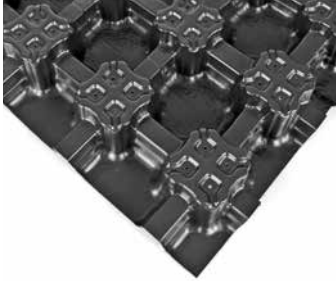

Drainage and water storage element made of thermoformed recycled polyolefin (mainly PE). Developed on the basis of the proven Floradrain® FD 60; usable on both sides. Due to the particularly large water storage cells FD 60 neo is especially suitable for use with intensive green roofs without water dam-up and under walkways and terraces. It can also serve as a permanent formwork to be filled with concrete as a base for other roof elements as e.g. driveways or foundations for furniture. Interlocking studs allow for a continuous and safe installation. Very stable with a compressive strength of ca. 190 kN/m² (with infill); water storage capacity: ca. 16 l/m² without infill, filling volume: ca. 27 l/m²; height ca. 60 mm; weight: ca. 2.2 kg/m².



Details on page 48

	Art. No.	Dimensions	Unit	Pallet
FD 60 neo	3062	ca. 2.30 m × 1.03 m (net 2.25 m × 1.00 m)	2.30 m ² board	450 m ²

Stabilodrain® SD 30



Drainage and water storage element made of thermoformed polystyrene, used for driveways and parking lots; can be installed on inverted roofs. Extremely solid; maximum load bearing capacity (without infill) ca. 500 kN/m²; installation with overlapping, therefore ca. 3 % surplus required; weight: ca. 3 kg/m²; height: ca. 32 mm. Specially shaped lateral studs allow for interlocking connection of the boards.

	Art. No.	Dimensions	Unit	Pallet
SD 30	3330	ca. 0.94 m × 2.00 m	1.88 m ² board	282 m ²

Drainage Elements

Floraset® Elements contain water storage cells, openings for aeration and diffusion as well as a drainage channel system on the underside. They are especially suited for large green roof areas without slope. In particular Floraset® FS 75 is also used for the System Build-up "Pitched Green Roof" with slopes up to 25°; in this case Floraset® FS 75 Elements are installed with the studs facing upwards. Floraset® Elements are made of expanded polystyrene (EPS) and are CFC-free.

Floraset® FS 50



Drainage board for extensive green roofs on flat roofs with and without slope; made of expanded polystyrene (EPS); CFC-free; with water storage cells, openings for aeration and diffusion as well as a continuous channel system on the underside. In-plane water flow rate tested according to European Standard EN ISO 12958. Density: ca. 20 kg/m³; weight: ca. 0.6 kg/m²; height: ca. 50 mm.

	Art. No.	Dimensions	Unit	Pallet
FS 50	3052	ca. 1.00 m × 1.00 m	1.00 m ² board	64 m ²

Floraset® FS 75

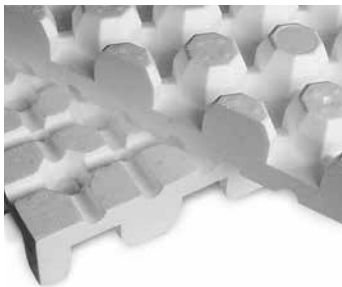

Drainage board usable on both sides, for extensive and simple intensive green roofs on flat and pitched roofs (slopes up to 25°, with studs facing upwards); made of expanded polystyrene (EPS); CFC-free; with water storage cells, openings for aeration and diffusion as well as a continuous channel system on the underside; in-plane water flow rate tested according to European Standard EN ISO 12958. Filling volume (installation with studs facing upwards): ca. 20 l/m² max.; weight: ca. 1.0 kg/m²; height: ca. 75 mm.

	Art. No.	Dimensions	Unit	Pallet
FS 75	3076	ca. 1.00 m × 1.00 m	1.00 m ² board	40 m ²

Filter Sheet Pin



Made of polyethylene; for punctual fixing of filter sheets on all drainage elements made of polystyrene hard foam (Floraset®). Ca. 1 Filter Sheet Pin/m² required. Head diameter: ca. 30 mm; pin diameter: ca. 8 mm; length of pin: ca. 34 mm.

	Art. No.	Unit
Filter Sheet Pin	9621	Bag of 100 pieces

Building Protection and Drainage Elements

Thanks to the attached rubber protection mat **Protectodrain®** combines the functions of a proven protection of the waterproofing and a stable drainage element. It allows for a quick drainage of excess water and prevents the vegetation from water logging. Even though consisting of 2 parts **Protectodrain®** can easily be disassembled into its components for a sorted disposal and material recycling.

Elastodrain® is made of solid rubber and can be driven over by wheel loaders. It is mainly applied on utilised roofs of underground car parks serving as a protection and drainage layer, both under vegetated areas and walkways or driveways. **Elastodrain®** strips or cuttings are used under terrace slabs or as a protective strip for edge areas of vegetated green roofs.

The **Fixodrain® XD 20** drainage sheet is mainly used for landscaping large industrial roofs. The thin **DBV 10** studded sheet is mainly used as a drainage and protective layer, e.g. under terraces.

Fixodrain® XD 20

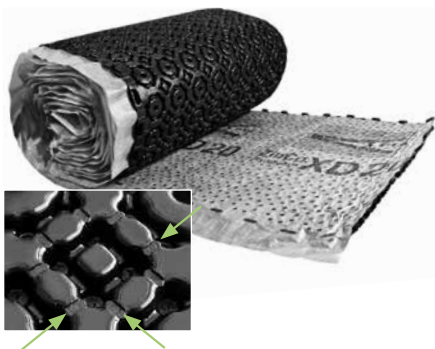

Quick-to-lay protection, drainage and water storage element made of thermoformed recycled polyolefin with attached filter sheet, to be used under extensive green roofs; with interlocking studs for connection on its long side. Also suitable for inverted roofs due to the diffusion openings and underlying connected channels. Colour: black/grey; height: ca. 20 mm; weight: ca. 1.0 kg/m²; max. load bearing capacity: ca. 50 kN/m²; water storage capacity: ca. 3 l/m².

	Art. No.	Dimensions	Unit	Pallet
XD 20	3021	ca. 1.00 m × 20.00 m	20 m ² roll	120 m ²



Details on page 48

Fixodrive® FX 50



Driveable and quickly installed protection and drainage mat made of thermoformed recycled polyolefin with attached filter sheet of strength class 3 to be used under intensive green roofs as well as driveways and walkways. With interlocking studs for connection on its long sides and diffusion holes. Also suitable for inverted roofs due to the diffusion openings and underlying connected channels. Colour: grey/white; height: ca. 20 mm, max. compressive strength up to 500 kN/m²; weight: ca. 1.8 kg/m², weight per roll: ca. 23 kg.

	Art. No.	Dimensions	Unit	Pallet
FX 50	3150	ca. 1.00 m × 15.00 m	15 m ² roll	90 m ²

Building Protection and Drainage Elements

Elastodrain® EL 202

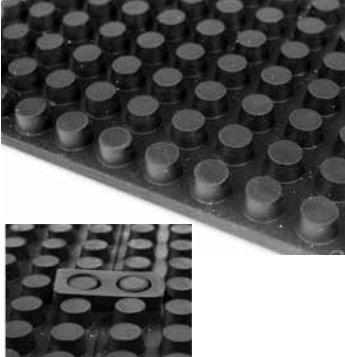

Especially developed for driveways and other build-ups with high load; extremely heavy duty drainage and building protection board made of fully vulcanized rubber; with rebated edge. It is spade resistant; reduces subsonic noise; non-rotting; compatible with bitumen; load bearing capacity at a compression of 10%: ca. 400 kN/m²; shore strength 75 Shore A; static bedding module ca. 285 MN/m³; weight ca. 19 kg/m²; total height ca. 19 mm; stud height ca. 12 mm; number of studs ca. 1200/m². The boards can be interconnected with special EL 202-Connectors. We recommend two connectors per running meter.

	Art. No.	Dimensions	Unit	Pallet
EL 202	3220	ca. 1.00 m × 1.00 m	1.00 m ² board	50 m ²
EL 202-Connector 2-holes	3221		Bag of 100 pieces	

Protectodrain® PD 250

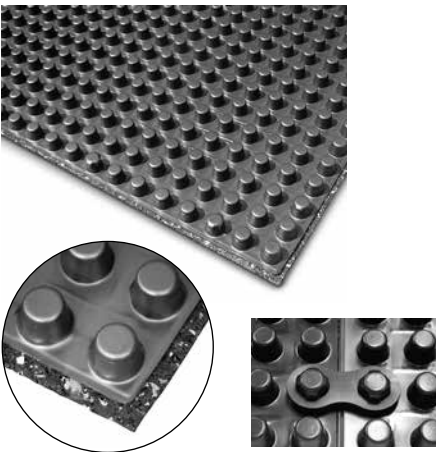

Stable and heavy duty drainage board made of thermoformed hard plastic (ABS) with attached rubber protection mat on the underside and all-round overlap. One-sided stud structure. Easy to transport due to light weight. Can be used as a protective layer in accordance with German Standard DIN 18351 T3, providing a drainage function at the same time, e.g. under landscaped underground garage roofs, terraces, etc.. In-plane water flow rate tested according to European Standard DIN EN ISO 12958. Trafficable, spade resistant, reduces subsonic noise, non-rotting, compatible with bitumen. Weight: ca. 5 kg/m²; load bearing capacity: 460 kN/m²; total height: ca. 25 mm; stud height: 20 mm; number of studs: > 600/m². The boards can be interconnected with special PD 250-Connectors which can be clipped onto the specially shaped edge studs of the adjacent elements. We recommend one connector per running meter.

	Art. No.	Dimensions	Unit	Pallet
PD 250	3250	ca. 1.00 m × 2.00 m	2.00 m ² board	150 m ²
PD 250-Connector	3251		Bag of 200 pieces	

Drainage Mat DBV 10

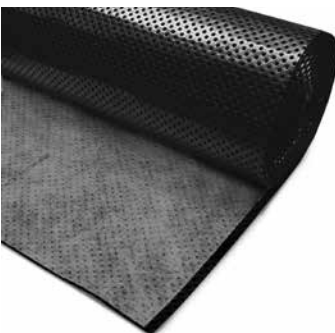

Studded sheet made of recycled polyolefin; with attached filter sheet overlapping on one side. Sheets can be connected lengthwise through interlocking studs. For building components lying in the ground or being covered by the ground; with multi-directional drainage channels for unimpeded water drainage; can be used as a drainage and protection layer under terrace pavements; as foundation wall protection or in front of perimeter insulation; pressure-resistant; low weight; easy to install. Colour: black, white/grey; compressive strength: ≥ 500 kN/m²; number of studs: ca. 3200/m²; weight: ca. 850 g/m²; height: ca. 10 mm.

	Art. No.	Dimensions	Unit	Pallet
DBV 10	3011	ca. 1.04 m × 12.00 m	12.5 m ² roll	150 m ²

Filter Sheets

Only when a drainage layer is covered with a filter sheet does it become a filter-stable drainage layer as required by German Standard DIN 4095 "Drainage for the protection of built structures". On drainage elements such as Floradrain®, Floraset®, etc. the Filter Sheet SF is sufficient, on drainage layers of loose materials (especially where they consist of sharp-edged materials) and in build-ups for driveways filter sheets of type TG or PV should be installed with ca. 200 mm overlap. Filter sheets should not be exposed to direct sunlight for a long period of time due to their low-level UV resistance. With CE-marking, for use in drainage layers and many other areas.

Filter Sheet SF

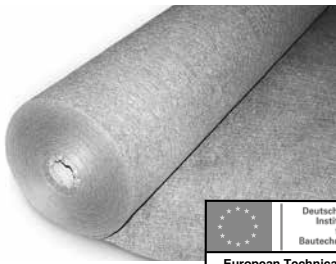

Details on page 48

Thermally strengthened filter sheet made of polypropylene; for normal mechanical stress and strain; applicable as a filter sheet on ZinCo drainage elements; non-rotting; water passage $Q = \text{ca. } 70 \text{ l/m}^2 \times s$ at 100 mm water column; effective opening width (O_{90}) according to European Standard EN ISO 12956: ca. $95 \mu\text{m}$; strength class 2; weight: ca. 100 g/m^2 .

	Art. No.	Dimensions	Unit	Pallet
Filter Sheet SF	2100	ca. 2.00 m × 100.00 m	200 m ² roll	4600 m ²
	2102	ca. 1.00 m × 100.00 m	100 m ² roll	2500 m ²
Blank	2101	ca. 2.00 m × 10.00 m	20 m ²	

Filter Sheet TG



Thermally strengthened filter sheet made of polypropylene; for high mechanical stress and strain, can therefore be used particularly as a filter sheet on the drainage element EL 202 and on gravel or stone chippings drainage layers; non-rotting; water passage $Q = \text{ca. } 40 \text{ l/m}^2 \times s$ at 100 mm water column; effective opening width (O_{90}) according to European Standard EN ISO 12956: ca. $85 \mu\text{m}$; strength class 3; weight: ca. 175 g/m^2 .

	Art. No.	Dimensions	Unit	Pallet
Filter Sheet TG	2192	ca. 2.00 m × 100.00 m	200 m ² roll	2400 m ²
	2193	ca. 1.00 m × 100.00 m	100 m ² roll	1200 m ²

Filter Sheet PV



Strengthened sheet made of polypropylene; therefore applicable in gravel layers or on Elastodrain® drainage elements under walkways and driveways; non-rotting; usable as protection layer where no water retention is desired (e.g. below Aquatec®, under driveways with Stabilodrain® or Fixodrive®). Water passage $Q = \text{ca. } 30 \text{ l/m}^2 \times s$ at 100 mm water column; effective opening width (O_{90}) according to European Standard EN ISO 12956: ca. $65 \mu\text{m}$; strength class 5; weight: ca. 300 g/m^2 .

	Art. No.	Dimensions	Unit	Pallet
Filter Sheet PV	2131	ca. 2.00 m × 50.00 m	100 m ² roll	1600 m ²

Filter sheets in different strength classes and weights available upon request.

Separation Sheet heat-resistant TVH 200



Heat-resistant sheet made of strengthened polyester to be used on top of Elastodrain® EL 202 for the manual installation of asphalt pavements. Please observe the installation instructions! Thickness: ca. 1.0 – 1.4 mm; weight: ca. 200 g/m^2 ; colour: white; max. tensile strength: min. 400 N/5cm; tensile extension lengthwise/crosswise: ca. 35/50 %; melting point > 200 °C.

	Art. No.	Dimensions	Pallet
Separation Sheet heat-resistant TVH 200	2220	ca. 2.00 × 100.00 m	1200 m ²

Mineral Substrates / Delivery Forms

Mineral Substrate Zincolit® Plus



Mineral Substrate "Zincolit® Plus" consisting of Zincolit® (sorted high quality crushed brick) enriched with selected mineral aggregates. Particularly suitable for extensive green roofs in single- or multiple layer build-up with sedum plants, as sub-substrate for intensive green roofs with a total substrate depth of more than 350 mm or as infill of drainage layers. The vegetation can be established by planting plug plants, laying vegetation mats, sowing cuttings by hand or by hydroseeding.

Zincolit® Plus Please note that ZinCo System Substrates are supplied in Big Bags, as bulk material or in silo.

Substrate Delivery Forms



Zincolit® Plus and the ZinCo System Substrates are available in various delivery types. Depending on the size and location of the roof and the type of substrate, a choice can be made from one of the following delivery types: bulk material, in Big Bags or in silo. Please don't hesitate to contact us should you require further information about our substrate delivery types.

Considerations before placing an order: Substrates, mainly those with a higher percentage of organic material, are subject to different rates of settlement. To reach the desired final height it is important to apply more substrate. The settlement factors are shown in the table.

Example: Desired final height: 70 mm of System Substrate "Rockery Type Plants"
Required amount: $70\text{ l/m}^2 \times 1.2 = 84\text{ l/m}^2$, e.g. 42 m³ of substrate are necessary for an area of 500 m².

Substrate	Settlement-factor	Weight/m ² saturated after settlement
Zincolit® Plus	1.10	ca. 13 kg/cm
System Substrate "Sedum Carpet"	1.12	ca. 14 kg/cm
System Substrate "Rockery Type Plants"	1.20	ca. 14 kg/cm
System Substrate "Heather with Lavender"	1.25	ca. 15 kg/cm
System Substrate "Roof Garden"	1.30	ca. 15 kg/cm
System Substrate "Lawn"	1.35	ca. 14 kg/cm

ZinCo Turbobag®



The ZinCo Turbobag®, a flexible chute with lockable and regulating outlet hose, is meant for the application of Zincolit® Plus, System Substrates "Sedum Carpet" and "Rockery Type Plants" as well as other free flowing bulk material with a maximum grain size of 32 mm. Using this effective method, substrates can be delivered as bulk material at a reasonable price and distributed easily over the roof. Technical data: size 5 m × 5 m; length of outlet hose ca. 3.5 m; max. load capacity: ca. 5000 kg; weight: ca. 60 kg; transport measures of empty bag: ca. 400 mm × 700 mm × 1300 mm.

	Art. No.	Unit
ZinCo Turbobag®	15035	Piece
for System Substrates, Zincolit®, gravel etc.		
Quad Leg Bridle Sling	15036	Piece
for ZinCo Turbobag®		

System Substrates

A system substrate that is adapted to meet the requirements of the selected plant community guarantees a durable and species-appropriate development. It is a decisive factor for the long-term functionality of the green roof. ZinCo offers various system substrates for different system build-ups and for different kinds of green roofs. Special customized substrates are also available upon request. The system substrates are produced in accordance with German FLL-Guidelines and are available in various delivery types. We will be happy to provide you with a quotation for your project.

System Substrate "Sedum Carpet"



System Substrate "Sedum Carpet" is particularly suitable for extensive green roofs on single or multi-layer system build-ups in combination with plants belonging to the plant list "Sedum Carpet". The plants are available as plug plants or Sedum cuttings.

Substrate "Sedum Carpet"

Please note that ZinCo System Substrates are supplied in Big Bags, as bulk material or in silo.

System Substrate "Rockery Type Plants"



System Substrate "Rockery Type Plants" is particularly suitable for extensive green roofs on multi-layer system build-ups in combination with plants belonging to the plant list "Rockery Type Plants". The plants are available as plug plants.

Substrate "Rockery Type Plants"

Please note that ZinCo System Substrates are supplied in Big Bags, as bulk material or in silo.

System Substrate "Heather with Lavender"

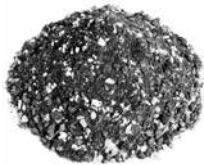

System Substrate "Heather with Lavender" is particularly suitable for simple intensive green roof build-ups in combination with plants belonging to the plant list "Heather with Lavender". A higher depth of system substrate also allows bushes and small trees to grow.

Substrate "Heather with Lavender"

Please note that ZinCo System Substrates are supplied in Big Bags, as bulk material or in silo.

System Substrate "Roof Garden"



System Substrate "Roof Garden" is particularly suitable for intensive green roof build-ups. Depending on the substrate depth, more demanding plants such as perennials, higher bushes and trees are possible.

Substrate "Roof Garden"

Please note that ZinCo System Substrates are supplied in Big Bags or as bulk material.

System Substrate "Lawn"



System Substrate "Lawn" is a fine grading substrate especially developed for the cultivation of lawn. A greater depth of system substrate also allows for the growth of perennials, bushes and trees.

Substrate "Lawn"

Please note that ZinCo System Substrates are supplied in Big Bags, as bulk material or in silo.



Applies to everything listed on this page, as well as the bagged substrate on page 17.

Precultivated Vegetation Mats

Premium ZinCo Sedum Mats

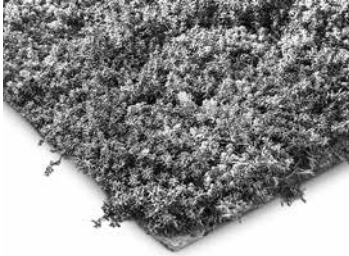

ZinCo Premium Sedum mats are supplied as a precultivated instant vegetation layer growing in a strong felt mat made from recycled British textiles. They include a blend of min. eight varieties of sedum plants with differing colours and leaf forms to provide extended interest and colour throughout the flowering period and enhancing biodiversity. Planting mix: minimum eight different sedum species; material: ca. 450 g/m² felt with scrim; thickness: ca. 25 mm; vegetation coverage: ca. 75 % minimum; saturated weight: ca. 25 kg per m².

	Art. No.	Dimensions
ZinCo Premium Sedum Mats	24 001 100	ca. 1.2 m ² (0.6 m x 2.0 m) or 2.4 m ² (1.2 m x 2.0 m)

Delivery options: Pallet delivery service for small orders, variety of delivery options for large orders on request.

Premium ZinCo Wildflower Mats



ZinCo Premium Wildflower Mats are supplied as a precultivated instant vegetation layer growing in a strong felt mat made from recycled British textiles. They include a biodiverse and colourful mixture of wildflowers, herbs and flowering perennials with a prolonged flowering period from April to September attractive to a wide range of pollinators. Planting mix: wildflowers, herbs and flowering perennials; material: ca. 450 g/m² felt with scrim; thickness: ca. 25 mm; vegetation coverage: 75 % minimum at point of sale; saturated weight: ca. 25 kg per m².

	Art. No.	Dimensions
ZinCo Premium Wildflower Mats	24 001 105	ca. 1.2 m ² (0.6 m x 2.0 m) or 2.4 m ² (1.2 m x 2.0 m)

Delivery options: Pallet delivery service for small orders, variety of delivery options for large orders on request.

Fertilizer

Plantfit 4 M



Granulated and compacted slow release fertilizer NPK 23-5-10 with at least 80 % coated particles. Used for extensive and intensive green roofs, post-planting and later on. One application of the slow release fertilizer is sufficient for an entire vegetation period. The recommended period to fertilize is spring.

	Art. No.	Unit
ZinCo Plantfit® 4 M	8550	Container with 2.5 kg
ZinCo Plantfit® 4 M	8551	Container with 10 kg
ZinCo Plantfit® 4 M	8552	Container with 25 kg

Seed Mixtures

ZinCo Seed Mixtures

Ready-to-sow seed mixtures with added organic adhesive. All seed mixtures are high quality mixtures which do not contain any blenders (annual or fast growing species with a short lifespan). Extremely high growing plants and plants with extensive foliage are deliberately avoided. The added organic adhesive serves to fix the seed mixture on the substrate. The substrate should be moist before starting with sowing – so the bonding process starts immediately. Alternatively, irrigation after sowing starts the same process. Please avoid accessing the sowed areas afterwards as this destroys the grid structure of the adhesive!

Quantity to be applied: from ca. 25 g/m². The quantity has to be increased with steeper slopes, e. g. ca. 40 g/m² for slopes of 20°. Also suitable for hydroseeding in combination with mulch material and fertilizer, if needed. Delivery in bags from 0.5 kg; short-term cool and dry storage. All seed mixtures are suitable from ca. 70 mm of System Substrate "Rockery Type Plants". A combination with Sedum cuttings is often recommended (e.g. 30 g Sedum cuttings/m² and 15 g seed mixture).



Available seed mixtures:

	Art. No.	Unit	Art. No.	Unit
Seed Mixture "Meadow Scent" see below	8003	0.5 kg bag	8005	2.0 kg bag
	8004	1.0 kg bag	8006	5.0 kg bag
Seed Mixture "Country Colours" see below	8013	0.5 kg bag	8015	2.0 kg bag
	8014	1.0 kg bag	8016	5.0 kg bag
Seed Mixture "Grassy Pasture" see below	8023	0.5 kg bag	8025	2.0 kg bag
	8024	1.0 kg bag	8026	5.0 kg bag
Seed Mixture "Bee Pasture" see below	8033	0.5 kg bag	8035	2.0 kg bag
	8034	1.0 kg bag	8036	5.0 kg bag

Seed mixture "Meadow Scent"

Seed mixture containing more than 25 different herbs – no grasses! For example, *Dianthus carthusianorum*, *Helianthemum nummularium*, *Hieracium pilosella*, *Petrorhagia saxifraga*, *Potentilla neumanniana*, *Prunella grandiflora* and *Thymus serpyllum*.

Seed mixture "Country Colours"

Seed mixture containing 60 % species from the seed mixture "Grassy Pasture" and 40 % from the seed mixture "Meadow Scent".

Seed mixture "Grassy Pasture"

Seed mixture containing more than 8 different grasses with a low foliage development. Main varieties: regional *Festuca ovina* and other *Festuca* and *Carex* varieties. This seed mixture can be applied without Sedum cuttings. It is characterised as being highly drought resistant and is especially capable of regeneration.

Seed mixture "Bee Pasture"

NEW

Colourfully blooming seed mixture, specially matching the needs of bees, containing ca. 35 different herbs without grasses for extensive green roofs with an extended blooming range.

Roof Tree Anchorage Robafix®



NEW

Ballasted tree anchorage system Robafix® specially designed for root ball fixation on green roofs; suitable for root balls with a diameter of up to ca. 0.8 m. Consisting of 3 anchorage base plates made of aluminium, dimensions ca. 400 × 360 mm each, with coach bolts; 4 grid elements made of recycled plastic, total area ca. 1.0 m², height ca. 30 mm; including set of adjustable straps to be tightened with a ratchet strap tensioner (removable); including protection mat made of coconut fibre with a diameter of ca. 800 mm; weight ca. 10 kg.

	Art. No.	Unit
Roof Tree Anchorage Robafix®	9015	Piece
Separate Ratchet Strap Tensioner	9011	Piece
Extension grid element (ca. 0.5 m x 0.5 m) for bigger root balls	9052	m ²

Pitched and Steep Pitched Green Roofs

Floraset® FS 75

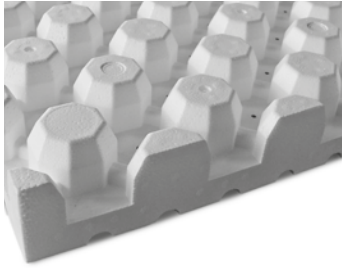

Floraset® FS 75 is the core piece of the System Build-up “Pitched Green Roof”. It can be used for pitched roofs with slopes up to 25°. FS 75 elements are made of expanded polystyrene (EPS); studs facing upwards interlocking with the substrate; drainage channel system on the underside; weight: ca. 1.0 kg/m²; height: ca. 75 mm, filling volume (installed with studs facing upwards): ca. 20 l/m².

	Art. No.	Dimensions	Unit	Pallet
Floraset® FS 75	3076	ca. 1.00 m × 1.00 m	1.00 m ² board	40 boards

Jute Anti-Erosion Net JEG



Coarse meshed net made of 100 % jute, to protect newly installed green roofs from wind and water erosion; jute is 100 % biologically degradable; used on pitched green roofs, banks, shores etc. For environmental reasons, the Jute Anti-Erosion Net is not flame retardant and therefore has to be protected from fire and embers. Weight: ca. 500 g/m²; mesh size: ca. 30–40 mm.

	Art. No.	Dimensions	Unit	Pallet
Jute Anti-Erosion Net JEG	2856	ca. 1.22 m × 70.00 m	85.4 m ² roll	683.2 m ²

Georaster®

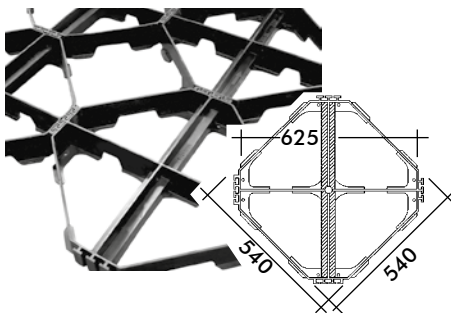

Georaster® elements are used for the System Build-up “Steep Pitched Green Roofs” with a slope of 20° to 35°. The Georaster® elements are made of polyethylene (HD-PE). They contain a reinforced centre bar to bear the shear forces. An integrated T-plug connection locks the elements together. Georaster® can also be used for reinforcement of gravel turf, for building driveways on a smooth/ soft subgrade or as slope protection. Height: ca. 100 mm; weight ca. 2.1 kg/piece; grid dimension 625 mm; requirement of 2.56 elements/m².

	Art. No.	Dimensions	Unit	Pallet
Georaster®	3400	ca. 540 mm × 540 mm	Piece	112 pieces

Shear Protection Accessories

Shear-Fix LF 150



Two-part screw anchor made of stainless steel for the absorption of tensile and shear forces of up to 1.5 kN, for use on waterproofed roofs; consisting of hanger bolt, length ca. 150 mm, Ø 10 mm, with welded base plate (fixed flange) and loose pressure plate (loose flange), Ø 70 mm each, thickness 4 mm each, incl. accessories for installation on wooden constructions. Shear-Fix LF 150 is a “loose/fixed flange” system according to the German Flat Roof Guidelines.

Scope of delivery:

1 hanger bolt with base plate, 1 pressure plate, 1 nut M10 + washer (both steel), 1 intermediate layer (EPDM), 2 separation and slip sheets (HDPE).

	Art. No.	Weight	Unit
Shear-Fix LF 150	956705	2 kg	Box with 5 units
Shear-Fix LF 150	956720	6.8 kg	Box with 20 units + face spanner

Accessories for Shear Protection

Shear-Fix LF 300 and LF 600

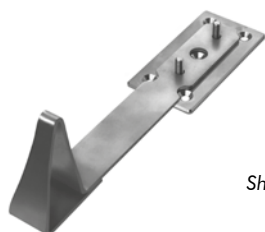

Shear-Fix LF 300



Shear-Fix LF 600

Shear retainer made of solid stainless steel, material thickness 5 mm, for its use on waterproofed pitched roofs to prevent the green roof build-up from slipping. To be installed in connection with Eaves Profile TRP 80 or TRP 140 (see also page 30) at the eaves or as shear barrier in the roof area.

The base plate is fixed on the supporting structure using 5 corrosion-protected screws. It is sealed additionally as a lose flange/ fixed flange construction using the same waterproofing material as for the roof itself. Height of both shear retainers: ca. 100 mm. Load capacity: max. 300 kg/retainer (LF 300); max. 600 kg/retainer (LF 600)

Scope of delivery:

1 base plate, 1 bracket, 2 nuts M10 (all stainless steel),
5 wood screws (galvanized steel), 1 bit, 2 interim layers of EPDM (1 large + 1 small)

	Art. No.	Weight	Length	Unit	Box
Shear-Fix LF 300	9568	1.8 kg	ca. 400 mm	Piece	5 pieces
Shear-Fix LF 600	9569	1.6 kg	ca. 150 mm	Piece	5 pieces

A stainless steel or aluminium cover plate for a visually attractive roof edge design is available upon request.

Support Brackets TSH 80/100

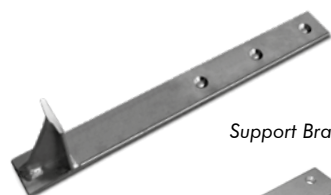

Support Brackets TSH 80



Support Brackets TSH 100

Support Bracket: Made of solid stainless steel; with sand-blasted, matt finish; ideal for use in connection with Eaves Profiles TRP 80 or TRP 140 for the bearing of shear forces on green roofs with slopes of min. 10°. To be fixed directly into the rafters.

Type "TSH 80": Made of flat steel 5 mm × 40 mm; height of front upstand ca. 80 mm; leg length ca. 400 mm; fixed using three 8 mm screws; can bear up to 150 kg/support bracket.

Type "TSH 100": Made of flat steel 5 mm × 50 mm; height of front upstand ca. 100 mm; leg length ca. 400 mm; fixed using four 8 mm screws; can bear up to 300 kg/support bracket.

	Art. No.	Unit
Support Brackets TSH 80	9563	Piece
Support Brackets TSH 100	9565	Piece

Both sets of Shear-Fix as well as the Support Brackets TSH 80/100 are subject to specific installation criteria regarding roof slope, max. load capacity, etc. We would be glad to provide you with support for your project-specific planning.

For further information on the installation, e.g. on concrete, please refer to the installation instructions which you will receive on request.

Eaves Profile TRP 140

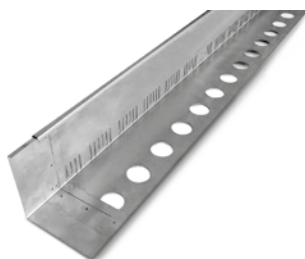

Eaves Profile TRP 140, bend-proof angle profile made of stainless steel; for finishing eaves on pitched green roofs; ideal in combination with support brackets; with drainage slots and welded joint connectors. Height of vertical leg: 140 mm.

	Art. No.	Dimension	Unit
Eaves Profile TRP 140	7782	Length 3 m	Piece

The Eaves Profile TRP 80 can be used as a shear protection in the roof area, for product specifications refer to page 30.

System Build-ups with Aquafleece® AF 300

The new Aquafleece® AF 300 is the core piece of the new System Build-ups “Urban Climate Roof” and “Irrigated Extensive Green Roof”. The combination of a highly capillary-effective fleece with woven material allows the Aquafleece® to distribute the water during irrigation while allowing excess water to pass through across the full area during a precipitation event. This allows for evenly distributed irrigation, while preventing the substrate from water logging.

Aquafleece® AF 300

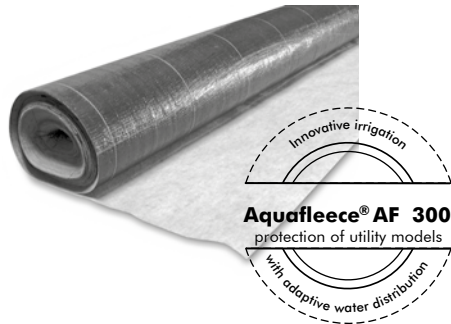

Highly capillary-effective fabric in particular for its use in conjunction with dripperlines type 500- L2 in irrigated extensive green roof build-ups. Application on top of ZinCo drainage elements for the System Build-ups “Urban Climate Roof” and “Irrigated Extensive Green Roof”.

The filter sheet is made of polyacrylic fibres, the woven fabric of polypropylene. Water absorption capacity: ca. 3–4 l/m²; flow rate: ca. 20 l/(m² × s); total weight: ca. 300 g/m²; total thickness: ca. 2.4 mm.

	Art. No.	Dimensions	Unit
Aquafleece® AF 300	2120	ca. 2.10 × 50.00 m	105 m ² roll

Dripperline 500-L2



Pressure compensating dripperline for the irrigation of green roofs in combination with Aquafleece® AF 300, outer diameter: ca. 16 mm; with internal drippers; dripper spacing: ca. 500 mm; dripper flow rate: ca. 1.6 l/h; pressure compensation: between 0.4 and 2.5 bar.

	Art. No.	Dimensions	Unit	Pallet
Dripperline 500-L2	9350	Ø ca. 16 mm	200 m roll	4800 m

Hook & Loop Tape



Hook & Loop Tape for fixing the Dripperlines 500-L2 on the Aquafleece® AF 300. Made of polyamid; colour: black. The Hook & Loop Tape is delivered in rolls of 25 m and is perforated every 120 mm (resulting in 208 pieces per roll).

	Art. No.	Dimensions	Unit
Hook & Loop Tape	9410	width 50 mm	25 m roll



These components are part of the System Build-ups “Irrigated Extensive Green Roof” and “Urban Climate Roof”.

For more detailed information please refer to the ZinCo planning guide “Green Roof 4.0”. Download at www.zinco-greenroof.com/downloads

System Build-up "Roof Garden" with Aquatec® AT 45

"Roof Garden" with Aquatec® AT 45 is a system build-up for intensive green roofs with reduced build-up height. The combination of the two products Aquatec® AT 45 and the Wicking Mat DV 40, both registered for patent approval, provides a plant adapted, water saving capillary irrigation. The System Substrate "Sedum Carpet" with a topping layer of Zincohum offers a base to apply a simple intensive vegetation, for example shrubs, lawns or similar. The dripperlines can be clipped into the division bars of the Aquatec® elements. The Irrigation Manager BM 4 controls the irrigation, supplying up to 1000 m² of roof area. In addition, you only need standard water pipes (diameter 32 mm) and connection accessories. The standard accessories required are available from ZinCo, please ask for a project-specific quotation.

Aquatec® AT 45

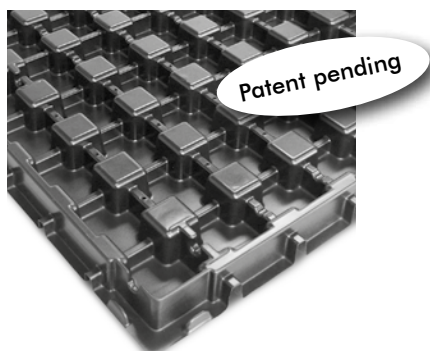

Water distribution, storage and drainage element made of thermoformed recycled hard plastic, developed especially to be used in combination with special dripperlines and the Wicking Mat DV 40. The basic principle is the distribution and storage of water in the cells of the elements. The water will be transported upwards by capillarity of the Wicking Mat when needed. The water supply takes place via dripperlines type 100-L1. These can be "clipped" into the dividing bars of the elements without using tools. The elements can be connected with each other via interlocking studs provided along one long side and one short side of the element. Material: ABS, colour: black; height: ca. 45 mm, weight: ca. 2.0 kg/m²; water storage volume of cells: ca. 17 l/m².

	Art. No.	Dimensions	Unit	Pallet
Aquatec® AT 45	3345	ca. 1.02 m × 2.02 m (net 1.00 m × 2.00 m)	2.00 m ² board	270 m ²

Wicking Mat DV 40



Water distributing polyester fleece with capillary-effective fibres on one side, especially developed for the use in combination with the water distribution, storage and drainage element Aquatec® AT 45. Material: polyester; colour: white (mat)/ grey (fibres); weight: ca. 600 g/m²; fibre length: ca. 40 mm.

	Art. No.	Dimensions	Unit
Wicking Mat DV 40	2160	ca. 2.00 m × 25.00 m	50 m ² roll
	2165	ca. 2.00 m × 10.00 m	20 m ² roll

Dripperline 100-L1



Dripperline for the irrigation of green roofs in combination with the water distribution, storage and drainage element Aquatec® AT 45 and the Wicking Mat DV 40. Outer diameter: ca. 16 mm, with internal drippers, dripper spacings 100 mm, dripper capacity ca. 1 l/h, pressure-compensating.

	Art. No.	Dimensions	Unit	Pallet
Dripperline 100-L1	9310	Ø ca. 16 mm	200 m roll	4800 m

Irrigation-Manager BM 4

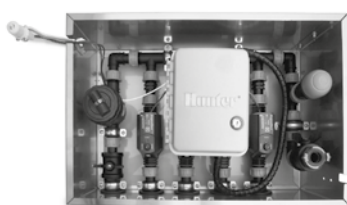

Pre-assembled programming unit for outdoor use for automated irrigation of green roofs; lockable stainless steel box incl. connection for water supply pipe 32 mm, filter, pressure regulator, water tap connection, irrigation time controller, (operated via batteries, therefore no power supply required), 4 magnetic valves 1 including connectors for 32 mm tube and rain sensor. Weight: ca. 14 kg; required water flow pressure: min. 1.5 bar.

	Art. No.	Dimensions
Irrigation-Manager BM 4	4045	L × W × H: ca. 580 mm × 390 mm × 250 mm

System Build-up "Stormwater Management Roof"

With this system build-up ZinCo offers a solution for the increasing heavy rain events and the resulting overload of the sewer systems. Spacer elements, combined with a Retention Flow Controller installed on top of roof drains, allow for additional water storage on the roof without affecting the upper layers (vegetated green roofs, walkways, driveways, etc.). The retained precipitation is then released with a delay over a pre-defined period of time into the sewer systems. The system build-up "Stormwater Management Roof" combines the advantages of a green roof with effective stormwater management. The system build-up is suitable for application on roofs without slopes.

Retention Spacer RS 60

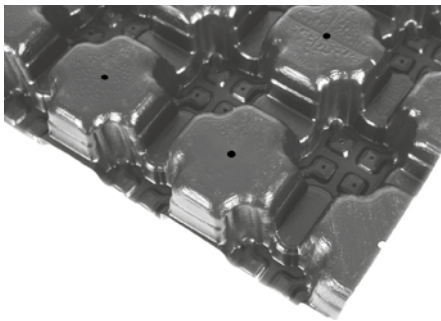

Powerful and highly transportation friendly spacer element made of thermoformed recycled polyolefin; height: ca. 60 mm; weight: ca. 2.2 kg/m²; with multidirectional drainage channel system on the underside and interlocking studs for length- and crosswise connection; max. water retention volume: ca. 55 l/m²; compressive strength at 10 % compression according to EN ISO 25619-2: ca. 40 kPa, for use in Stormwater Management Roofs on roof surfaces without inclination.

	Art. No.	Dimensions	Unit	Pallet
Retention Spacer RS 60	3408	ca. 2.30 × 1.03 m (net 2.25 × 1.00 m)	ca. 2.30 m board	net 225 m ²

Retention Spacer RSX 65 / RSX 100

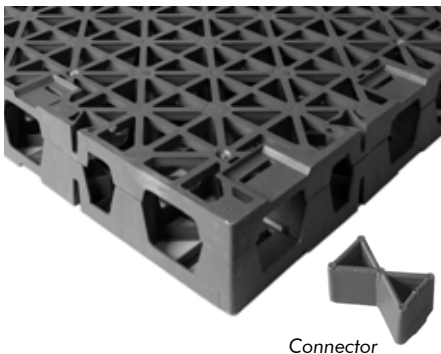

Powerful, heavy duty but lightweight spacer element made of thermoformed polypropylene. Colour: green; height: ca. 65 mm; integrated void system; max. water retention volume: ca. 60 l/m². Compressive strength according to EN ISO 25619-2: 50 t/m²; for use in Stormwater Management Roofs on roof surfaces without inclination with heavy loads such as walkways or driveways or deep substrate levels on top.

	Art. No.	Dimensions	Unit	Pallet
Retention Spacer RSX 65	3402	ca. 0.6 × 0.6 m	0.36 m ² board	53.28 m ²
Retention Spacer RSX 100	3403	ca. 0.6 × 0.6 m	0.36 m ² board	34.56 m ²
Further heights on request				
Connector	9622		4 pcs per spacer element required 50 pcs/unit	

Retention Flow Controller Set RDS 48 / RDS 28

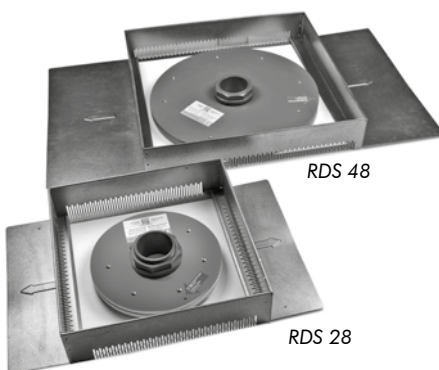

Set consisting of **Flow Controller RD 48** and **Inspection chamber KS 10/57** (see page 24); Adjustable flow controller to be installed on flat roofs over water outlets with a clamping flange; flow controller flange made of rigid PVC; overflow pipe and adjusting rings made of plastic; flange diameter: ca. 480 mm; overflow pipe diameter: ca. 75 mm; maximum attenuation height: ca. 85 mm; weight ca. 4.5 kg.

Set consisting of **Flow Controller RD 28** and **inspection chamber KS 10/40** (see page 24); Adjustable flow controller to be installed on flat roofs over water outlets with a contact flange; flow controller flange made of rigid PVC; overflow pipe and adjusting rings made of plastic; flange diameter: ca. 280 mm; overflow pipe diameter: ca. 75 mm; maximum attenuation height: ca. 85 mm; weight ca. 2.0 kg.

If required, depending on build-up installed: Extension Pieces **KSA 10/40** or **KSA 10/57**; weight ca. 1.5 kg or 2.0 kg (see page 24).

	Art. No.	Unit
Retention Flow Controller Set RDS 28	4000	Set
Retention Flow Controller Set RDS 48	4002	Set

20 2018 000 238.0 –
"protection of utility models"
in Germany

Inspection Chambers

Green roofs must be drained safely and constantly. A basic requirement for proper drainage is accessibility to the roof outlets at all times for checking and cleaning purposes. Therefore, an inspection chamber is installed over each roof outlet. The chamber height can be adjusted to match the system build-up height.

Inspection Chamber



Inspection chambers made of plastic-coated aluminium; covers and extension pieces made of plastic-coated galvanized steel; for installation onto drainage elements, in combination with run-off limiters, or within the substrate layer; fits all drain outlet sizes. The inspection chambers can also be supplied with a lock. Combined with a KSA extension piece, the inspection chambers can be used for higher build-ups.

Outer dimensions of the KS*/30-types: ca. 300 × 300 mm;
with extended flange 300 × 530 mm; Aperture dimension: ca. 240 × 240 mm.

Outer dimension KS 10/40 ca. 400 x 400 mm;
with extended flange: ca. 400 × 630 mm; Aperture dimension: ca. 340 × 340 mm.

Outer dimension KS 10/57 ca. 570 x 570 mm;
with extended flange: ca. 570 × 1000 mm; Aperture dimension: ca. 500 × 500 mm.

	Art. No.	Height	Unit
Inspection Chamber KS 6/30-GR	4005	ca. 60 mm	Piece
Inspection Chamber KS 6/30 (weight: 2.6 kg)	4006	ca. 60 mm	Piece
Inspection Chamber KS 10/30-GR	4009	ca. 100 mm	Piece
Inspection Chamber KS 10/30 (weight: 2.8 kg)	4010	ca. 100 mm	Piece
Inspection Chamber KS 10/40 (weight: 4.5 kg)	4011*	ca. 100 mm	Piece
Inspection Chamber KS 10/57 (weight: 9.0 kg)	4014*	ca. 100 mm	Piece
Extension Piece KSA 8/30 (weight: 1.0 kg)	4008	ca. 80 mm	Piece
Extension Piece KSA 20/30 (weight: 2.0 kg)	4020	ca. 200 mm	Piece
Extension Piece KSA 10/40 (weight: 1.5 kg)	4012	ca. 100 mm	Piece
Extension Piece KSA 10/57 (weight: 2.0 kg)	4015	ca. 100 mm	Piece
Locking Set	9031		Set

Inspection Chambers made of stainless steel are available upon request.

* Locking set included in scope of delivery.

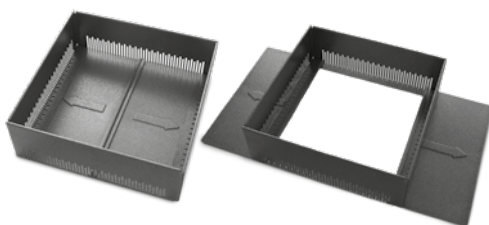

Pull out flange - inside the chamber for easy transportation and storage

Pull out flange - pulled out prior to installation

Low transport volume, yet fixed positioning achieved by superimposed load when installed.

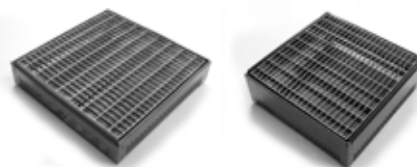

Inspection Chamber KS 6/30-GR and KS 10/30-GR with detachable galvanized grill

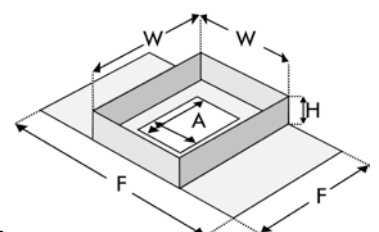

H = Height
W = Width
F = Flange
A = Aperture dimension

Inspection Chambers

Inspection Chamber AKS 8



Made of galvanized and plastic coated steel; with one open side and three flanged sides, developed for water outlets near parapets or water spouts, can be used on upstands with insulation material fillet, perforated edges to install without tools. Can be combined with the Extension Pieces KSA 8/30 and KSA 20/30. Outer dimensions of chamber: ca. 300 mm × 300 mm; aperture dimensions: ca. 240 mm × 240 mm; flange on three sides ca. 85 mm.

	Art. No.	Height	Unit
Inspection Chamber AKS 8 (weight: 2.9 kg)	4007	ca. 80 mm	Piece
Extension Piece KSA 8/30 (weight: 1.0 kg)	4008	ca. 80 mm	Piece
Extension Piece KSA 20/30 (weight: 2.0 kg)	4020	ca. 200 mm	Piece
Locking Set	9031		Set

Inspection Chamber KS 30/30, stainless steel / fillable cover / Extension Piece



High quality inspection chamber made of stainless steel; with lateral drainage slots; with lockable and walkable cover with openings for water; vertically adjustable membrane collar for continuous installation of the filter sheet. Colour: stainless steel; weight: ca. 4.0 kg; outer dimensions: ca. 300 mm × 300 mm; aperture dimensions: ca. 240 mm × 240 mm.

	Art. No.	Height	Unit
Inspection Chamber KS 30 – stainless steel (with stainless steel lid)	4035	ca. 300 mm	Piece
Extension Piece KSA 15-E (weight: ca. 1.8 kg)	4036	ca. 150 mm	Piece
Inspection Chamber KS 30/30 – stainless steel - „B“ (lid can be planted or filled with gravel)	4038	ca. 360 mm	Piece

Cascade Inspection Chamber KKS 30/40



Inspection Chamber made of aluminium and galvanized steel; powdercoated; with pull out flange; colour: old silver-antique; included catch basin for connecting down pipes with diameter 80, 90, 100, 110, 120 and 125 mm; incl. backflow flap; leafguard and maintenance access; weight: ca. 7.00 kg; height: ca. 300 mm; outer dimension of the chamber: ca. 400 mm x 400 mm; accessories: Extension Piece KSA 10/40

	Art.-No.	Height	Unit
Cascade Inspection Chamber KKS 30/40	4032	ca. 300 mm	Piece
Extension Piece KSA 10/40	4012		

Dam-up irrigation

Challenging roof gardens are irrigated most effectively within the drainage layer by accumulating water on the waterproofing. The amount of accumulated water can be regulated using an Inspection and Irrigation Chamber. It is mechanically swimmer-controlled. For ecological reasons, mainly rainwater should be used for irrigation, e.g. from a cistern, but tap water is also possible.

Inspection and Irrigation Chamber KB 30

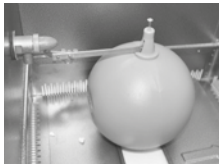
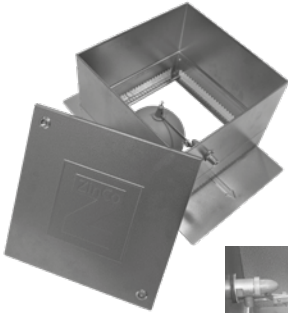

Swimmer

Swimmer-controlled automatic irrigation system for dam-up irrigation on zero-pitched roofs, separation distances according to DIN EN 1717, set consisting of inlet valve (0.5 inch) with swimmer, Inspection Chamber KS 10/40, Extension Piece KSA 20/40, lockable lid, weight ca. 7.65 kg.

	Art. No.	Height	Unit
Inspection and Irrigation Chamber KB 30	4034	ca. 300 mm	Piece

Dam-up Element, stainless steel

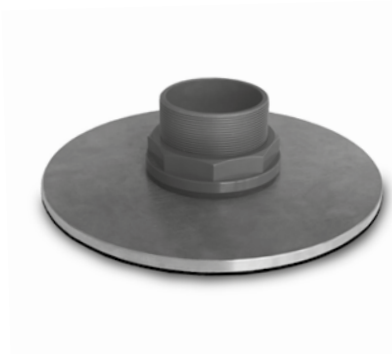

Dam-up element for placing above flat roof drains with a contact flange and minimum size DN 100. Weight: ca. 4.6 kg. Consisting of a stainless steel flange with rubber sealing on the underside, diameter ca. 280 mm, and a vertically adjustable dam-up element (adjustment range ca. 10 – 75 mm) made of plastic, inner diameter ca. 75 mm.

	Art. No.	Unit
Dam-up Element, stainless steel	4146	Piece

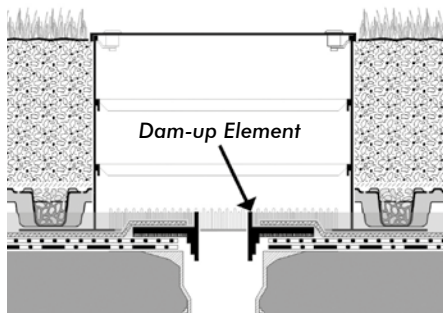

Drainage Channels

Drainage Channels FR – Galvanized Steel and Plastic-Coated

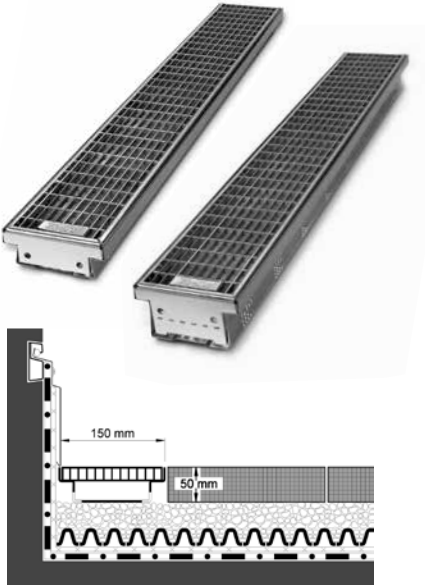

Solid drainage channel, made of galvanized and plastic-coated steel sheet, to be screwed at the joints, with walkable, galvanized grill; ensures efficient water drain-off in front of facades and areas with a higher water accumulation; allows for reduced connection height around thresholds and on terraces (special solution in accordance with Standard DIN and FLL). If necessary, the endings can be turned inwards manually (only FS 75). Grill mesh width: ca. 33 mm × 11 mm; width: ca. 150 mm.

	Art. No.	Height	Unit
FR 50-1 (length ca. 1.00 m; weight: ca. 4.7 kg)	4741	ca. 50 mm	Piece
FR 50-2 (length ca. 2.00 m; weight: ca. 9.2 kg)	4742	ca. 50 mm	Piece
FR 75-1 (length ca. 1.00 m; weight: ca. 5.0 kg)	4751	ca. 75 mm	Piece
FR 75-2 (length ca. 1.00 m; weight: ca. 9.8 kg)	4752	ca. 75 mm	Piece
90°-Corner for FR 50 (weight: ca. 4.0 kg)	4745	ca. 50 mm	Piece
90°-Corner for FR 75 (weight: ca. 4.3 kg)	4755	ca. 75 mm	Piece
Leg length ca. 500 × 500 mm each			
Screw Kit for connecting the Drainage Channels	9130		Piece
Project specific cuttings according to customer's specification	4998		Piece
Screw Kit for locking the "grill" to Drainage Channel FR	9135		Piece

Drainage Channel FR – Vario

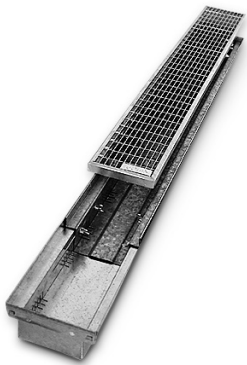

Drainage Channel with adjustable length as fitting piece for the standard Drainage Channel FR 50. The grill can be cut to the required length; the cut edge has to be protected from corrosion. Available in dimensions: 600–1000 mm and 1150–2000 mm; height 50 mm; weight: 5.4 kg and 10 kg.

	Art. No.	Height	Unit
FR 50 – Vario 100 (horizontally adjustable from 600 to 1000 mm)	4746	ca. 50 mm	Piece
FR 50 – Vario 200 (horizontally adjustable from 1150 to 2000 mm)	4744	ca. 50 mm	Piece
Galvanizing Spray (400 ml)	9540		Piece

Drainage Channels

Drainage Channel FTR – Aluminium



Aluminium drainage channel adjustable from above; cover with oblong hole slots: 30 mm × 8 mm or with galvanized steel grating, grill mesh width: 33 mm × 11 mm. The channel absorbs facade runoff water and directs it quickly and safely into the drainage layer. This allows reduced connection heights in the door and terrace area. Channel body slotted at sides, slot width ca. 3 mm, with integrated butt joint connector, which can be used in upright position as an end-piece.

	Art. No.	Dimensions	Unit
FTR – 55/75 A (cover made of aluminium adjustable 55–75 mm; weight: ca. 2.5 kg)	4747	ca. l: 1.00 m, w: 145 mm	Piece
FTR – 75/100 A (cover made of aluminium adjustable 75–100 mm; weight: ca. 2.7 kg)	4757	ca. l: 1.00 m, w: 145 mm	Piece
FTR – 55/75 corner, prefabricated 90°-corner (cover made of aluminium; weight: ca. 1.1 kg; leg length outside: ca. 250 mm × 250 mm)	4749	ca. l: 0.25 m, w: 145 mm	Piece
FTR – 75/100 corner, prefabricated 90°-corner (cover made of aluminium; weight: ca. 1.2 kg; leg length outside: ca. 250 mm × 250 mm)	4759	ca. l: 0.25 m, w: 145 mm	Piece
FTR – 55/75 G (with galvanized grate adjustable 55–75 mm; weight: ca. 5.5 kg)	4748	ca. l: 1.00 m, w: 145 mm	Piece
FTR – 75/100 G (with galvanized grate adjustable 75–100 mm; weight: ca. 5.7 kg)	4758	ca. l: 1.00 m, w: 145 mm	Piece

Balcony and Terrace Channel

Balcony and Terrace Channel BTR – Stainless Steel



Vertically adjustable channel made of premium stainless steel; grill with oblong hole slots, channel body with lateral slots for drainage; includes connectors and integrated grill locking mechanism. Channel with ca. 107 mm; vertically adjustable from 40 mm to 55 mm.

	Art. No.	Length	Unit
Balcony and Terrace Channel BTR (weight: ca. 3.6 kg)	4771	ca. 1.00 m	Piece
90°-Corner for BTR (weight: 1.2 kg)	4775	ca. 220 mm × 220 mm	Piece
End piece to be inserted into the BTR Channel	4773		Piece

Terrace Grills

Terrace Grill – vertically adjustable



Vertically adjustable drainage grill made of galvanized steel with coated gravel retainer frame. The rough height adjustment is done by selecting the corresponding gravel retainer frame; if necessary in combination with the 60 mm extension piece; fine adjustment with a screwdriver from above, without removing the grill. In this way, the height-adjustable terrace grill 400 mm × 400 mm is suitable for build-up heights from 65 mm to 185 mm. For direct installation in paving over the water outlet; grill mesh width: ca. 33 mm × 12 mm.

	Art. No.	Outer Dimensions	Aperture Dimensions	Height	Unit
TR-H 40 × 40 – 65	4404	ca. 400 mm × 400 mm	ca. 340 × 340 mm	65–95 mm	Piece
TR-H 40 × 40 – 95	4409	ca. 400 mm × 400 mm	ca. 340 × 340 mm	95–125 mm	Piece
TR-H 40 × 20 – 65	4402	ca. 400 mm × 200 mm	ca. 340 × 140 mm	65–95 mm	Piece
TR-H 50 × 50 – 65	4405	ca. 500 mm × 500 mm	ca. 440 × 440 mm	65–95 mm	Piece
Extension piece: TR-H 40 × 40	4412	ca. 400 mm × 400 mm	ca. 340 × 340 mm	60 mm	Piece

Terrace Grill – TR-H 40 × 40 – Stainless Steel



Visually appealing terrace grill made of stainless steel; vertically adjustable for build-up heights of 65 mm–95 mm; height adjustment from above on site with screwdriver, cover with oblong holes in accordance with the look of the BTR Channel.

	Art. No.	Outer Dimensions	Aperture Dimensions	Height	Unit
TR-H 40 × 40 – 65	4474	ca. 400 mm × 400 mm	ca. 340 × 340 mm	65–95 mm	Piece

Inspection Chamber BES / Extension Piece

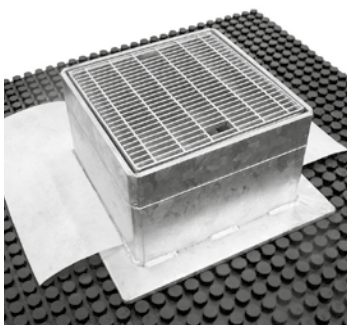

Trafficable inspection chamber made of galvanized steel; outer dimensions: ca. 300 mm × 300 mm; dimensions with flange: ca. 400 mm × 400 mm; with lockable grill; mesh width: ca. 11 mm × 41 mm; sand trap made of aluminium with load distributing flange; weight: ca. 30 kg; aperture: ca. 200 mm × 200 mm.

	Art. No.	Height	Unit
BES 125 (weight: ca. 26.0 kg)	4812	ca. 125 mm	Piece
BES 200 (weight: ca. 32.0 kg)	4820	ca. 200 mm	Piece
BES 300 (weight: ca. 39.0 kg)	4830	ca. 300 mm	Piece
Extension Piece for BES (weight: ca. 8.0 kg)	4825	ca. 25 mm	Piece
EL 202-Support Board for BES	3225	ca. 20 mm	Piece

Separations

Concrete Kerb



Concrete Kerb

For edging plant areas, bordering walkways and terraces or for building troughs etc. Leg length: 250 mm × 300 mm; reversible; length 500 mm; weight: ca. 28.5 kg only.

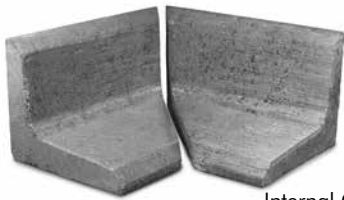

Internal Corner

Internal Corner

Two angular stones bevelled to an angle of 45°; to create a 90° internal angle. Leg length: ca. 480 mm × 480 mm; weight: ca. 46–48 kg.



External Corner

External Corner

Two angular stones bevelled to an angle of 45°; to create a 90° external angle. Leg length: ca. 230 mm × 230 mm; weight: ca. 33–35 kg.

	Art. No.	Dimensions	Unit	Pallet
Concrete Kerb	5025	ca. 500 mm × 300 mm × 250 mm	Piece	32 pieces
Internal Corner	5028	H: ca. 250 mm	Piece	10 pieces
	5030	H: ca. 300 mm	Piece	10 pieces
External Corner	5029	H: ca. 250 mm	Piece	10 pieces
	5031	H: ca. 300 mm	Piece	10 pieces

Eaves Profiles

Eaves Profiles TRP 80/TRP 140

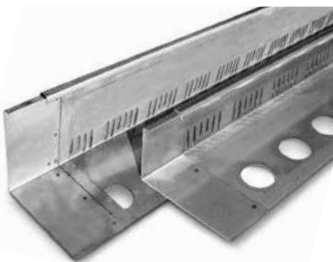

Extra strong angle profiles made of stainless steel, especially for edgings and enclosures of terraces and walkways, but can also be used as gravel retainer or on the eaves or roof edges in case of missing upstands. In connection with shear retainers the TRP 140 can also be used as an eaves edging or shear barrier on pitched green roofs. Perforation in the support leg for fixing purposes and slotted perforation for water passage as on standard eaves profiles; with welded-on butt joints for straight line edges; leg heights 80 mm and 140 mm; length: ca 3 m each.

	Art. No.	Dimensions	Unit
TRP 80	7780	L: 3.00 m, H: 80 mm	Piece
TRP 140	7782	L: 3.00 m, H: 140 mm	Piece

Eaves Profiles

Eaves Profiles DP 55 / DP 80 / DP 120

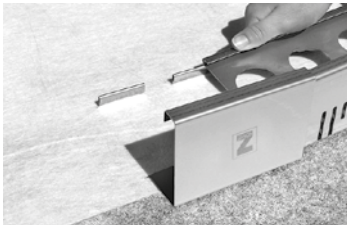

Angle profile made of metal; it is used for bordering green areas, as a gravel retainer or where there is no upstand at the eaves or roof edge. Continuous perforation of the support leg allows for fixation to the waterproofing. Slot perforation for water drainage of ca. 8.500 mm²/m. Length: ca. 3 m. Suitable connectors made of aluminium for professional joint connection of the eaves profiles (butt joint: ca. 5 mm). Suitable external and internal corners in various profile heights; leg length: ca. 250 mm × 250 mm.

A = Aluminium, E = Stainless Steel

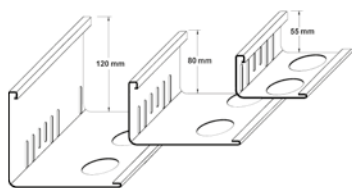

Connector

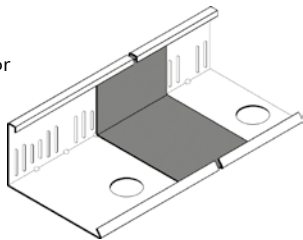

External Corner



Internal Corner

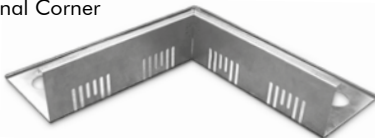

	Art. No.	Height	Unit
DP 55-A	7777	ca. 55 mm	Bundle of 10 pieces (30 m)
DP 55-E	7779	ca. 55 mm	Bundle of 10 pieces (30 m)
External Corner DP 55-A	7792	ca. 55 mm	Piece
External Corner DP 55-E	7793	ca. 55 mm	Piece
Internal Corner DP 55-A	7707	ca. 55 mm	Piece
Internal Corner DP 55-E	7706	ca. 55 mm	Piece
Connector for DP 55	7778	ca. 55 mm	Piece
DP 80 A Aluminium	7781	ca. 80 mm	Bundle of 10 pieces (30 m)
DP 80 E Stainless Steel	7784	ca. 80 mm	Bundle of 10 pieces (30 m)
External Corner DP 80-A	7794	ca. 80 mm	Piece
External Corner DP 80-E	7795	ca. 80 mm	Piece
Internal Corner DP 80-A	7710	ca. 80 mm	Piece
Internal Corner DP 55-E	7709	ca. 80 mm	Piece
Connector for DP 80	7783	ca. 80 mm	Piece
DP 120-A	7785	ca. 120 mm	Bundle of 10 pieces (30 m)
DP 120-E	7788	ca. 120 mm	Bundle of 10 pieces (30 m)
External Corner DP 120-A	7796	ca. 120 mm	Piece
External Corner DP 120-E	7797	ca. 120 mm	Piece
Internal Corner DP 120-A	7714	ca. 120 mm	Piece
Internal Corner DP 120-E	7713	ca. 120 mm	Piece
Connector for DP 120	7787	ca. 120 mm	Piece

DP-FIX

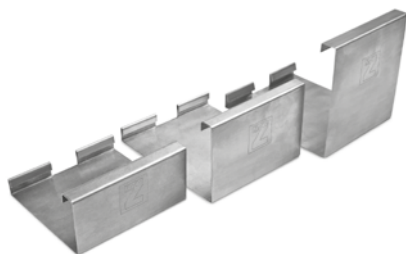

The ideal way to fix DP Profiles without penetrating the roof waterproofing. The DP-Fix aluminium support is delivered with a pre-slotted fixing mat 750 mm × 500 mm. DP-Fix is a butt joint connector which ensures an even appearance. On roofs with a slope of up to 5°, it can be used as edging board, to border green areas, to retain gravel or as intersectional piece (between gravel, greenery and paved areas). Also available in stainless steel upon request.

	Art. No.	Height	Unit
DP-FIX 55, incl. fixing mat	7705	55 mm	Piece
DP-FIX 80, incl. fixing mat	7708	80 mm	Piece
DP-FIX 120, incl. fixing mat	7712	120 mm	Piece

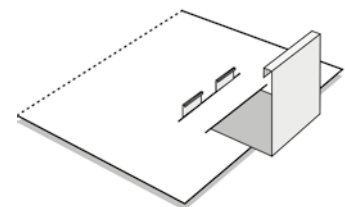
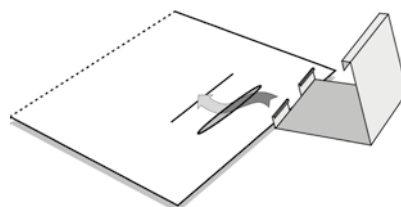
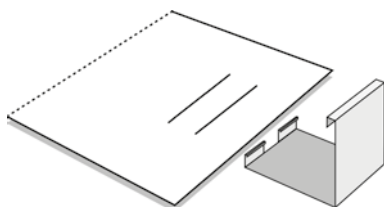

Gravel Retainers

For clear separation e.g. between substrate and gravel strips we offer a wide range of gravel retainers. Due to production by extrusion the new gravel bars are very stable. They can also be used on both sides, so that you can service two heights with one product. And because of the profile length of 2 m, the gravel retainers are easy to transport, store and process.

Gravel Retainer KL 60/80 / Gravel Retainer KL 80/100 Gravel Retainer KL 100/120 / Gravel Retainer KL 140/160

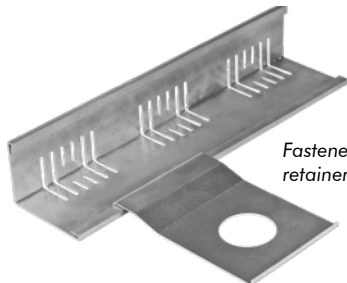
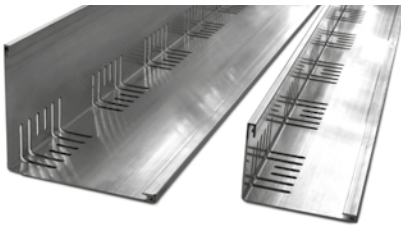

Fastener for gravel retainers

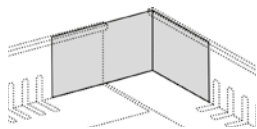

Creation of an external corner with corner connector

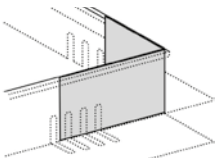

Creation of an internal corner with corner connector

Angle profiles made of natural aluminium for the separation of different build-ups, e.g. gravel strip and vegetated area, strips of Zincolit® or similar.

Gravel Retainer KL 60/80: Material thickness: ca. 1.5 mm; length ca. 2.0 m; weight ca. 1.1 kg/piece

Gravel Retainer KL 80/100: Material thickness: ca. 1.5 mm, length ca. 2.0 m; weight ca. 1.6 kg/piece

Gravel Retainer KL 100/120: Material thickness: ca. 1.8 mm, length ca. 2.0 m; weight ca. 2.1 kg/piece

Gravel Retainer KL 140/160: Material thickness: 2.2 mm on average, length ca. 2.0 m; weight ca. 4.0 kg/piece, with integrated joint connector

	Art. No.	Height	Unit
KL 60/80	7760	ca. 60/80 mm	Bundle of 15 pieces (30 m)
Connector for KL 60/80	7907	ca. 60/80 mm	15 pieces
Corner Connector for 60 mm	7916	60 mm	10 pieces
Corner Connector for 80 mm	7917	80 mm	10 pieces
KL 80/100	7767	ca. 80/100 mm	Bundle of 10 pieces (20 m)
Connector for KL 80/100	7909	ca. 80/100 mm	10 pieces
Corner Connector for 80 mm	7917	80 mm	10 pieces
Corner Connector for 100 mm	7918	100 mm	10 pieces
KL 100/120	7765	ca. 100/120 mm	Bundle of 10 pieces (20 m)
Connector for KL 100/120	7911	ca. 100/120 mm	10 pieces
Corner Connector for 100 mm	7918	100 mm	10 pieces
Corner Connector for 120mm	7919	120 mm	10 pieces
KL 140/160	7745	ca. 140/160 mm	Bundle of 10 pieces (20 m)
Connector for KL 140/160	7746	ca. 140/160 mm	10 pieces
Corner Connector for 140 mm	7920	140 mm	10 pieces
Corner Connector for 160 mm	7921	160 mm	10 pieces
Fastener for Gravel Retainer (when used with Shear Fix LF 150)	7902	ca. 48 /95 mm	5 pieces
Fastener for Gravel Retainer KL	7905	ca. 100 /150mm	10 pieces

Prefabricated welded corners available upon request.



Fastener for Gravel Retainer when used with Shear Fix LF 150

Clamping and Protection Profiles

The waterproofing needs to be taken up at any connections and needs to be protected against slipping with clamping profiles. This applies in particular for wall connections. The minimum height of these profiles depends on local regulations in building and constructions. The upper end of these protective profiles needs to be waterproof. Clamping profiles applied in this field need to be resistant against bending; the distance between the single fastening devices shall not exceed 200 mm.

Clamping Profile AP 40



Clamping profile, e.g. for fixation of root barriers, or pond liners to concrete kerbs or planters, made of aluminium; pre-drilled holes, spacing between the holes: ca. 200 mm. Profile height: ca. 40 mm.

	Art. No.	Length	Unit
AP 40	7620	3.00 m	Bundle of 10 pieces

Clamping Profile AP 60

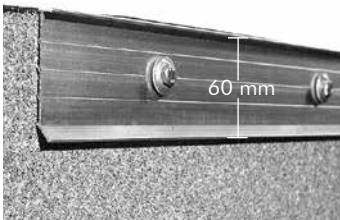

Clamping profile, for fixation of root barriers, plastic and bituminous waterproofings, made of aluminium; pre-drilled holes, spacing between the holes: ca. 200 mm. Profile height: ca. 60 mm.

	Art. No.	Length	Unit
AP 60	7625	3.00 m	Bundle of 20 pieces
AP 60 Internal Corner	7626	ca. 0.25 m × 0.25 m	Piece
AP 60 External Corner	7627	ca. 0.25 m × 0.25 m	Piece
AP 60 Butt Joint Connector	7628		Piece

Clamping and Protection Profile AP 150

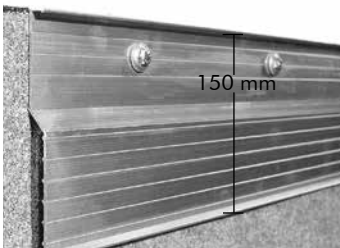

Bending resistant clamping and protection profile made of extruded aluminium, for plastic and bituminous waterproofings, with cover for the protection layer, pre-drilled holes, spacing between holes: ca. 200 mm. Profile height: ca. 150 mm.

	Art. No.	Length	Unit
AP 150	7640	3.00 m	Bundle of 20 pieces
AP 150 Internal Corner	7641	ca. 0.25 m × 0.25 m	Piece
AP 150 External Corner	7642	ca. 0.25 m × 0.25 m	Piece
AP 150 Butt Joint Connector	7643		Piece



On request also available as bended profile in higher version.

Fall Protection Fallnet®

When working on roof areas, which also includes the maintenance of green roofs, the use of personal safety equipment to prevent from falling off the roof is a requirement at heights of over 3 m (regulated in accident prevention legislation and specific DIN standards). As the inventor of (roof) **non-penetrating fall prevention equipment**, we can provide you with a comprehensive range of safety equipment with our Fallnet® system suitable for all building-specific situations on your roof. The various types of safety equipment can be installed without penetrating the roof membrane, from the single fixing point device to the rail solution and the Guardrail system.

Fallnet® ASG-Maintenance Guardrail



NEW

Edge protection system according to EN 13374 class A used as a collective fall prevention system during maintenance works on roofs with an upstand and an inclination of up to 5°. The installation takes place without roof penetrations with load applied over the entire surface. The Maintenance Guardrail can be installed either vertically or with an inclination of 67.5°. Maximum post spacing: 2.6 m.

	Art. No.	Dimensions	Unit
Post module	3480	ca. 1.75 m × 1.2 m × 0.6 m (L × H × W)	Piece
Hand rail/midrail	9880	ca. 2.0 m × 42 mm (L × D)	Piece
	9881	ca. 3.0 m × 42 mm (L × D)	Piece
	9882	ca. 6.0 m × 42 mm (L × D)	Piece
Corner joint for hand rail/midrail	9885		Piece

Fallnet® SR – Fixing device – Single point

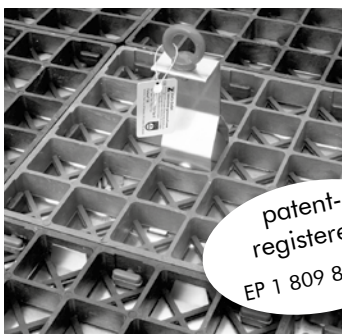

patent-registered
EP 1 809 834 B1

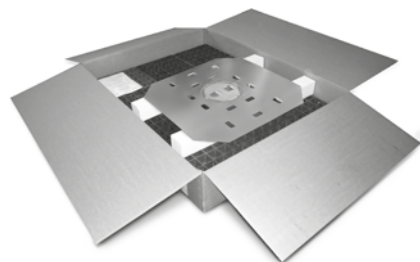

Fixing device for fall protection without roof penetration, tested and certified according to European Standard EN 795:2012 Type E. It consists of single grid elements which are plugged together to a unit and covered with at least 110 kg/m² of superimposed load (e.g. ZinCo System Substrate, gravel or comparable bulk material). The fixing point with ring eye is situated centrally in the unit.

Grid elements made of RC polyethylene, height: ca. 30 mm, dimensions: ca. 330 mm × 330 mm; total surface area: 2.00 m × 2.67 m (delivery in grid segments of 1.00 m × 1.33 m).

Fixing point with ring eye: Support and fixing eye made of stainless steel, height ca. 200 mm, base plate made of aluminium, ca. 750 mm × 750 mm.

Fallnet® SR offers the following system advantages: little space required (5.33 m²), therefore suitable for small or narrow roof areas. Variable forms possible due to connectable grid elements. Installation within existing green roof is easily possible.

	Art. No.	Dimensions	Unit
Fallnet® SR	9050	ca. 2.00 m × 2.67 m	4 pre-assembled segments + 1 fixing point
Fallnet® SR packed	9053	ca. 2.00 m × 2.67 m weight: 47.0 kg	Box 1400 × 1050 × 230 mm
Extension Segment SR for Fallnet® SR	9051	ca. 1.00 m × 1.33 m	1 segment

Fall Protection Fallnet®

Fallnet® SR Rail – Fixing device – Horizontal Rail System

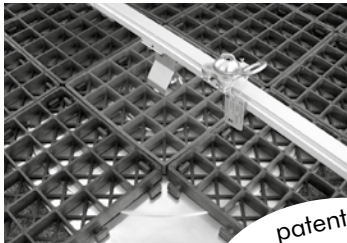

patent-registered
EP 1 809 834 B1

Rail system with horizontally gliding fixing point ("Runner") to be installed with grid elements, rail supports, rail components and superimposed load. Fixing device for fall protection without roof penetration, tested and certified according to European Standard EN 795, 2012 Types D + E.

Grid elements made of RC polyethylene, height: ca. 30 mm; delivery in grid segments of 1.00 m x 1.33 m

Rail support made of stainless steel, height: ca. 225 mm, base plate made of aluminium, ca. 750 mm x 750 mm; max. distance between both rail supports: 4.5 m

Fixing Rail made of high quality aluminium alloy, standard lengths of 2.00 m, 3.00 m and 6.00 m. Adjusting pieces upon request.

Grid Unit AE

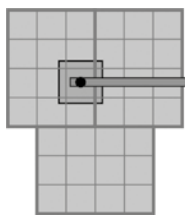

Grid Unit M

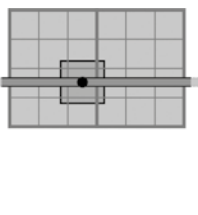

	Art. No.	Components/Dimensions	Unit
Grid Unit AE	49047	Grid unit for beginning and end of the rail; consisting of 3 pre-assembled grid segments of 1.0 x 1.33 m each	Piece
Grid Unit M	49057	Grid unit for the middle of the rail, consisting of 2 pre-assembled grid segments of 1.0 x 1.33 m each	Piece
Rail Support	9057	one rail support per grid segment is required	Piece
Rail 2 m*	49064	without coating, pre-punched	Piece
Rail 3 m*	9065	without coating, pre-punched	Piece
Rail 6 m*	9071	without coating, pre-punched	Piece
Joint Connector	9056	made of stainless steel, incl. screw set	Piece
End Piece Rail	9068	incl. stopper	Piece
90°- End Piece Rail	9069	without coating, pre-punched	Piece
3-way Junction Unit	49063	for 90° junctions	Piece
Runner	9067	made of stainless steel, with anchorage point	Piece
Fallnet® Rail – Drilling Set	9527	in metal tool box, consisting of drilling template, twist drill Ø 10.5 mm, 90° countersink drill bit Ø 20.5 mm, instructions	Piece
Warning sign "Set rope length"	9073	Aluminium sign with a spring hinge to be installed in the lower groove of the rail	
Rail Fitting Pieces	90700030–90700195	Rail fitting pieces available in lengths from 300 mm to 1.95 m in 50 mm increments. The final digits of the article number correspond to the length of the fitting piece.	

* The rails have drillholes at the ends to fix the joint connector. If a rail has to be cut in-situ to fit a special measurement, the necessary hole can be drilled exactly using the drilling set.

Mounting Kit Rail



Mounting set consisting of additional aluminum nameplate, installation instructions, user manuals, control cards and assembly paste.

	Art. No	Unit
Mounting Kit Rail	9095	Set

Fall Protection Fallnet®

Fallnet® SB 200-Rail – Fixing device – Horizontal Rail System

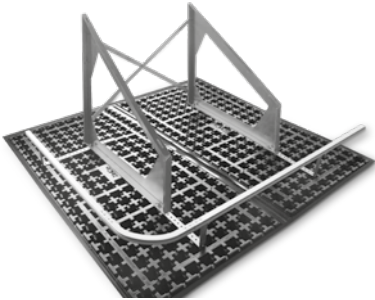

Rail system with horizontally gliding fixing point ("Runner") to be installed in combination with the ZinCo Solar Base SB 200, Solar Base Frame SGR or ZinCo Guardrail Base GB / GB Corner, fixing device for fall protection without roof penetration, tested and certified according to European Standard EN 795: 2012 Type D + E.

	Art. No.	Material/Dimensions	Unit
Rail Support	9075	Stainless Steel, L: ca. 600 mm	Piece
Rail Support	9076	Stainless Steel, L: ca. 1200 mm	Piece

PPE-Set (Personal Protective Equipment)

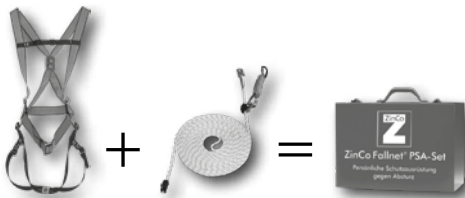

Personal Protective Equipment for safe working on roofs, tested and certified to European Standard EN 363, suitable for ZinCo fixing devices "Fallnet®". Consisting of a harness in accordance with European Standard EN 361, 15 m rope (diameter 12 mm), rope shortener, shock absorber, connector and instruction manual; delivery in a stable metal case.

	Art. No.	Dimensions	Unit
PPE-Set	9024	Ø 12 mm Rope length ca. 15 m	Set

Guardrail Solutions

Guardrail Base GB / GB Corner

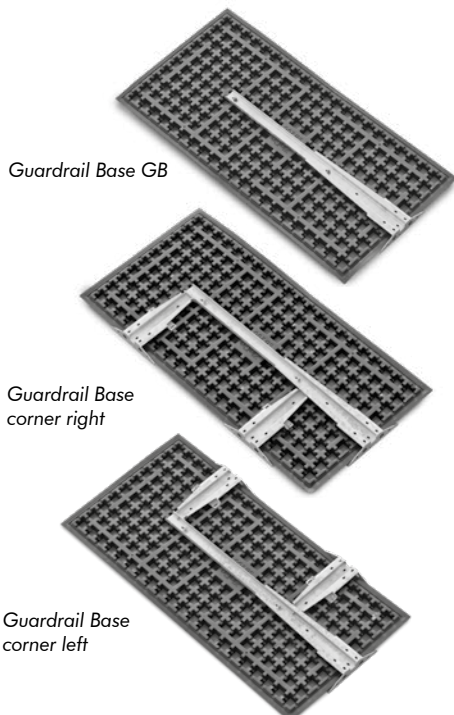

Made of profiled recycled hard plastic (ABS), with integrated aluminium profiles on the underside, post support(s) with fixing flange made of galvanized steel, suitable for all posts with appropriate fixing flange (hole distance 100 mm × 75 mm), tested according to German Standard DIN 1055-3 for horizontal loads up to 1 kN/m, consisting of:

- Base plate:** length × width ca. 2.00 m × 1.00 m, height: ca. 43 mm, filling volume ca. 16 l/m²
- Post support:** height: ca. 35 mm from top edge of Guardrail Base GB
- Fixing flange:** 4 slots for screws M10, hole distance: 100 mm × 75 mm
- Total height (Base plate + Post support):** ca. 78 mm

	Art. No.	Dimensions	Unit
Guardrail Base GB	3420	ca. 2.00 m × 1.00 m	Piece
Guardrail Base GB corner left	3445	ca. 2.00 m × 1.00 m	Piece
Guardrail Base GB corner right	3446	ca. 2.00 m × 1.00 m	Piece

Combinable with the fixing device Fallnet® SB 200-Rail, making a modified railing base. Other accessories as well as project-specific modifications are available upon request.

Guardrail Solutions

Railing System SG 40-E, Stainless Steel



midrail+
midrail support

handrail +
handrail support

The SG 40-E stainless steel Railing System is planned by our technical department and adapted to your project's needs. We will be happy to give you a detailed and itemised quotation. The following is an example of the different components.

	Art. No.	Dimensions	Unit
Railing Post E	9800	Ø 40 mm × 2 mm, L: 1.20 m	Piece
Handrail E	9801	Ø 40 mm × 2 mm, L: 3.00 m	Piece
Handrail Support E	9806	Ø 18 mm, ca. 100 mm vertically adjustable	Piece
Handrail Coupling E	9808	for handrail Ø 40 mm	Piece
Midrail E	9802	Ø 12 mm × 1.5 mm, L: 3.00 m	Piece
Midrail Support E	9807	with ring and fixing screw	Piece
Midrail Coupling E	9809	for midrail Ø 12 mm	Piece

Further accessories and project-related modifications are available upon request.

Railing System SG 40-S, Galvanized Steel

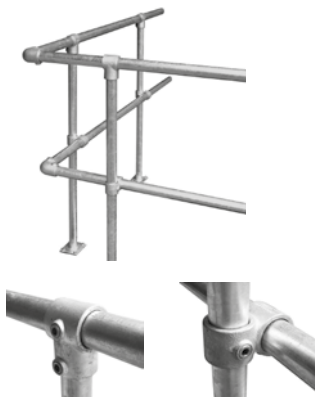

handrail +
handrail support

midrail+
midrail support

Functional and stable railing to be installed without drilling, made of galvanized steel, harmonized with the ZinCo Guardrail Base GB / GB Corner. The Railing System can be adjusted to suit the individual project. It consists of several individual components. Depending on the project, components other than those listed may be required.

	Art. No.	Dimensions	Unit
Railing Post S	9850	Ø 42 mm × 3 mm, L: 1.20 m	Piece
Handrail S	9851	Ø 42 mm × 3 mm, L: 6.00 m	Piece
Handrail Support S	9856	for handrail Ø 42 mm	Piece
Handrail Coupling S	9858	for handrail Ø 42 mm	Piece
Midrail S	9852	Ø 34 mm × 3 mm, L: 6.00 m	Piece
Midrail Support S	9857	for midrail Ø 34 mm	Piece
Midrail Coupling S	9859	for midrail Ø 34 mm	Piece

Guardrail Base GB-F (for emergency escape routes)

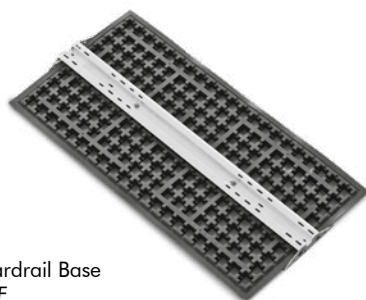

Guardrail Base
GB-F

Construction Base for Railing Systems without any roof penetration made of profiled ABS (Acrylonitrile Butadiene Styrene) plastic with integrated aluminium profiles on the underside and post support profile on the upper side of the base with two fixing flanges made of galvanized steel, one at each narrow end, for the fixing of 4 bolts M 10 at a distance of 100 x 75 mm; height of fixing flange above upper edge of base plate: ca. 35 mm; filling volume up to upper edge of base plate: ca. 16 l/m²; tested according to German Standard DIN 1055-3 for horizontal loads up to 1 kN/m; total height ca. 78 mm. Prepunched for post distances of 0.875 m, 1.00 m, 1.20 m or 1.80 m.

	Art. No.	Dimensions	Unit
Guardrail Base GB-F	3498	ca. 2.00 m × 1.00 m	Piece

Vertically Adjustable Pedestals Elefeet®

Elefeet® Pedestals



Pedestal, continuously adjustable in height, made of stable polypropylene, for easy installation of entirely and solidly enclosed concrete walkways or natural stone slab paving on areas with or without slope.

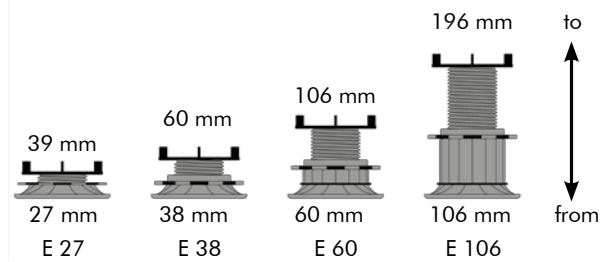

Flexible and simple vertical adjustment by turning the adjusting swivel for exact levelling. Integrated 3 mm wide spacers achieve straight joints and a good drainage function. 4 adjustable standard types cover heights between 27 mm and ca. 196 mm. Heights of up to 500 mm can be realized by combining them with suitable Extension Pieces. The wide pedestal foot transmits the load into the sub-construction. Perfect for surfaces without slopes to keep the deck dry.

The Protection Mat Elastosave ES 30 provides additional protection of the waterproofing (see page 7).

Load bearing capacity up to 600 kg per support plate or 300 kg per 90° segment.



Extension Pieces in different heights (can be combined as needed)

	Art.-No.	Unit	Pack
Elefeet® E 27 (vertically adjustable from 27 to 39 mm)	9660	Piece	Box with 78 pieces
Elefeet® E 38 (vertically adjustable from 38 to 60 mm)	9661	Piece	Box with 60 pieces
Elefeet® E 60 (vertically adjustable from 60 to 106 mm)	9662	Piece	Box with 42 pieces
Elefeet® E 106 (vertically adjustable from 106 to 196 mm)	9663	Piece	Box with 36 pieces
Extension Piece A 12 for Elefeet® (ca. 12 mm high)	9664	Piece	Box with 120 pieces
Extension Piece A 22 for Elefeet® (ca. 22 mm high)	9665	Piece	Box with 120 pieces
Extension Piece A 67 for Elefeet® (ca. 67 mm high)	9666	Piece	Box with 90 pieces

ZinCo Elefeet® Adjusting Tool



The hook shaped Adjustment Tool, made of approx. 3 mm steel, is available as an accessory for the energy efficient height adjustment of Elefeet® E 38, E 60 and E 106. The Adjusting Tool is adapted to the adjusting swivel of the Elefeet®.

	Art. No.	Unit
Adjusting Tool for height adjustment	960047	Piece

Buffer Pad



When using thin ceramic terrace tiles it is recommended to lay a Buffer Pad on top of Elefeet® pedestals; made of recycled rubber, thickness ca. 3 mm.

	Art. No.	Unit
Buffer Pad	9636	Box with 100 pieces

Elefeet® Support Rail System

Elefeet® Support Rail System



The Elefeet® Support Rail System is based on extruded light aluminium profiles, material EN AW 6060 T66, with corresponding connectors in galvanized steel. In combination with Elefeet® pedestals it allows for the rapid installation of stable terrace substructures. It is especially suitable in case there is no stable framing all around the decking. The decking can consist of concrete or natural stone slabs, as well as wooden or WPC planks. The double-profiled groove of the profiles ensures a safe, fast and aligned positioning of all components; the screw groove fixes the screws and ensures their safe fastening.

The system is designed for the load class Z according to European Standard EN 1991-1-1 (balconies, roof terraces, loggias).

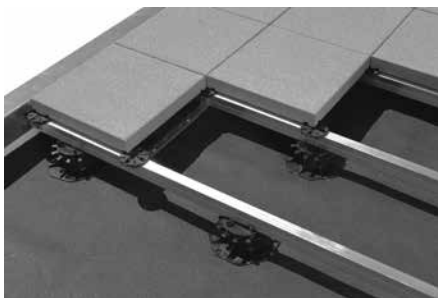

Installation example

	Art.-No.	Length	Art.-No.	Length	Art.-No.	Length
Support Profile 34 x 34 mm	960010	2.00 m	960011	4.00 m	960012	6.00 m
Support Profile 34 x 49 mm	960000	2.00 m	960001	4.00 m	960002	6.00 m

Elefeet® Support Rail Accessories

Rail Connectors

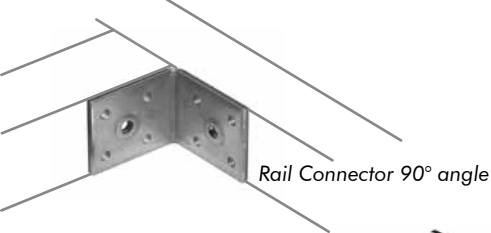

Rail Connector 90° angle

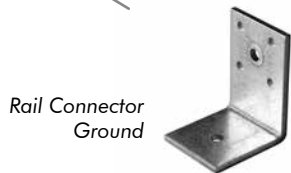

Rail Connector Ground



Rail Connector low to high rail



Rail Connector - longitudinal, rigid

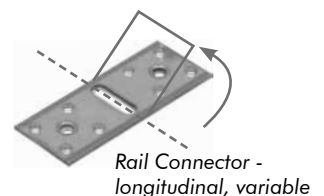

Rail Connector - longitudinal, variable

To ensure a safe and stable installation of the rail system, a variety of connectors with special knobs for anti-twist protection are available to meet different installation requirements and conditions. These can be inserted into the rail grooves and screwed together securely and accurately. All connectors are made of galvanized steel, but are also available in stainless steel on request.

	Art.-No.	Unit
Rail Connector 90° angle	960030	Container with 40 pieces incl. screws
Rail Connector Ground	960031	Container with 40 pieces incl. screws
Rail Connector - longitudinal, rigid	960032	Container with 40 pieces incl. screws
Rail Connector - longitudinal, variable	960033	Container with 40 pieces incl. screws
Rail Connector low to high rail	960034	Container with 15 pairs incl. screws

Elefeet® Support Rail Accessories

Distance Holder



Variable spacer to produce an axial dimension of 350 - 625 mm, with special knobs for anti-twist protection. Spacer made of galvanized steel, but also available in stainless steel on request.

	Art.-No.	Unit
Distance Holder variable 350 - 625 mm	960045	Bundle of 10 pairs incl. screws

Edge Holder

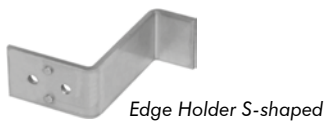

Edge Holder S-shaped

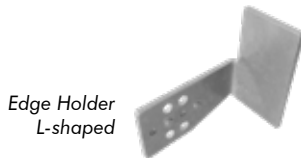

Edge Holder L-shaped

S-shaped edge holder to provide edgings for paving slabs (60 mm overhang, 30 mm upstand) and L-shaped edge holder for lateral fixing to provide edgings for paving slabs at the end of the rail, each of them with special knobs for anti-twist protection. Edge holders are made of galvanized steel, but are also available in stainless steel on request.

	Art.-No.	Unit
Edge Holder S-shaped	960035	Bucket with 30 pieces incl. screws
Edge Holder L-shaped	960036	Bucket with 20 pieces incl. screws

Support Plate



Support plate for paving slabs to be placed and screwed onto the support rails, with 3 mm joint spacers and support disc. Joint spacers can be broken off.

	Art. No.	Unit
Support Plate	960050	Pack with 52 pieces incl. screws and bit

Fixing Clamp Elefeet® to Rail

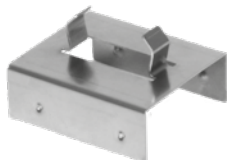

Adapter bracket made of stainless steel, for toolless attachment of the Elefeet® Support Rail to the head of the Elefeet® pedestal, toolless assembly by simple clipping.

	Art. No.	Unit
Fixing Clamp Elefeet® to Rail	960052	Pack with 10 pieces

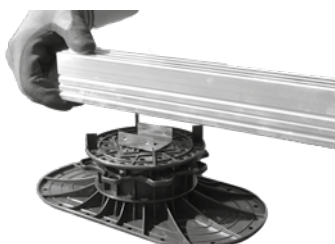

Pedestals Accessories

Elefeet® Mitre Cut Support

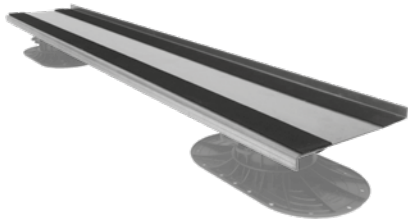

The Elefeet® Mitre Cut Support is used when slabs are laid in edge areas which are not at right angles with the installation pattern of the slabs. The 170 mm wide profile is installed parallel to the edge on the Elefeet® and supports even small slab cuttings. The 15 mm high continuous upstand borders the slabs. The attached rubber lining ensures a non-slip surface.

	Art. No.	Length	Unit
Elefeet® Mitre Cut Support	9657	ca. 2.00 m	Piece

Elefeet® Cantilever Arm Support / Elefeet® Edge Retainer Support

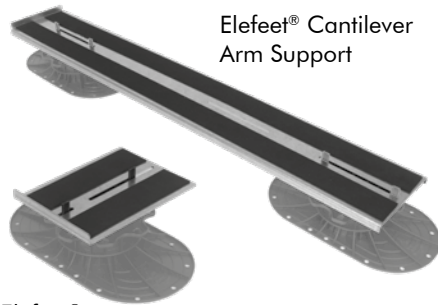

Elefeet® Cantilever Arm Support

Elefeet® Edge Retainer Support

The Elefeet® Cantilever Arm Support and Edge Retainer Support made of galvanized steel are used to lay concrete slabs firmly along the edge. The lack of support around the edges is compensated for by the Cantilever Arm Support, which is placed solidly on at least two Elefeet® pedestals. The weight of the slab pavement ensures the firmness. The upstand on the Elefeet® Edge Retainer Support prevents the slabs from slipping away. The Cantilever Arm Support is fixed to the Elefeet® by slots. A non-slip rubber surface prevents the slabs from sliding off.

	Art. No.	Unit
Elefeet® Cantilever Arm Support width 125 mm, length 800 mm, with non-slip rubber surface	9658	Piece
Elefeet® Edge Retainer Support width 125 mm, length 175 mm, with non-slip rubber surface	9659	Piece

Drainage Grill

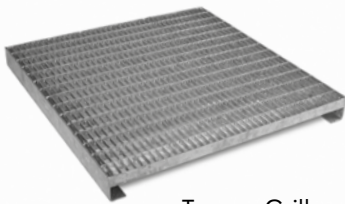

Terrace Grill

The drainage grill made of galvanized steel, mesh width ca. 44 mm × 11 mm, as alternative to concrete slabs can be installed over roof outlets or by means of cantilever arm support along facades. It allows quick passage of rainwater into the cavity under the paving.

	Art. No.	Outer Dimension	Unit
Terrace Grill			
TR-F 40 × 40 × 4 (weight: ca. 4.5 kg; aperture dimensions: ca. 340 mm × 400 mm)	4210	ca. 400 mm × 400 mm, H = 40 mm	Piece
TR-F 40 × 40 × 5 (weight: ca. 5.0 kg; aperture dimensions: ca. 340 mm × 400 mm)	4213	ca. 400 mm × 400 mm, H = 50 mm	Piece
TR-F 50 × 50 × 5 (weight: ca. 6.3 kg; aperture dimensions: ca. 440 mm × 500 mm)	4215	ca. 500 mm × 500 mm, H = 50 mm	Piece

Drainage Channel BTR – Stainless Steel



Vertically adjustable channel made of premium stainless steel; grill with oblong hole slots, channel body with lateral drainage slots; includes connectors and integrated grill locking mechanism. Channel width ca. 107 mm; vertically adjustable from ca. 40 mm to 55 mm.

	Art. No.	Length	Unit
Drainage Channel BTR (weight: ca. 3.6 kg)	4771	ca. 1.00 m	Piece
90°-Corner for BTR (weight: ca. 1.2 kg)	4775	ca. 220 mm × 220 mm	Piece

Slab Pavements Accessories

Elastoring

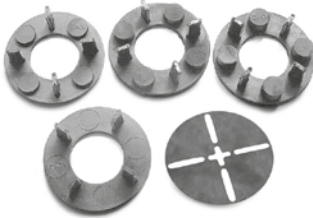

Ring-shaped pedestal, made of synthetic rubber, diameter 120 mm, heights available in 5, 10, 15 and 20 mm. With 5 mm integrated joint spacer. Elastoring can be used on roofs without standing water. Slightly uneven roof areas can be adjusted with the various ring heights and the 1 mm Spacer Ring / Slip Protection.

	Art. No.	Height	Unit
Elastoring ER 5	9630	ca. 5 mm	Box with 100 pieces
Elastoring ER 10	9631	ca. 10 mm	Box with 100 pieces
Elastoring ER 15	9632	ca. 15 mm	Box with 100 pieces
Elastoring ER 20	9633	ca. 20 mm	Box with 100 pieces

Levelling Pad



The 1 mm Levelling Pad, made of natural rubber, is placed on the Elastoring in order to balance out slight differences in height. It can also be used on the header of Elefeet® pedestals as slip protection.

	Art.No.	Unit
Levelling Pad	9635	Box with 100 pieces

Load Distributing Board



In order to protect the waterproofing from heavy point loads and the resulting damage, a load distributing rubber board can be used beneath the Elastoring. With the Load Distributing Board (200 × 200 mm), the build-up height is raised by ca. 4 mm.

	Art. No.	Unit
Load Distributing Board thickness 4 mm, dimensions 200 × 200 mm	9634	Box with 50 pieces

Spacer 5 mm



Spacer, thickness of legs ca. 5 mm, height of legs ca. 11 mm, made of non rotting PE plastic, for an easy, time saving and lasting precise laying of slabs on a bedding layer; fourth leg removable without tools in case of asymmetric laying of slabs.

	Art. No.	Thickness of legs	Form	Unit
Spacer with base plate	9623	5 mm	four legs	Bag of 300 pieces

Spacer 3 mm (for use with Elefeet®)



This spacer with a leg thickness of ca. 3 mm ensures a uniform joint pattern even if an Elefeet® pedestal cannot be placed directly below the intersection point of the slabs (e.g. when mitre cut supports or edge retainers are used); fourth leg removable without tools in case of asymmetric laying of slabs.

	Art. No	Thickness of legs	Form	Unit
Spacer with base plate	9624	3 mm	four legs	Bag of 300 pieces 3 bags per box

Photovoltaics and Green Roofs



Solar energy generation has become an integral part of the flat roof landscape, in terms of fully exploiting roof areas. A combination of green roof and solar technology is ideal. The green roof build-up functions as additional load to provide stability for the solar panels, even in the case of strong winds and storms. Compared to gravel roofs, green roofs increase the efficiency of the photovoltaic plant due to the comparatively lower ambient temperature.

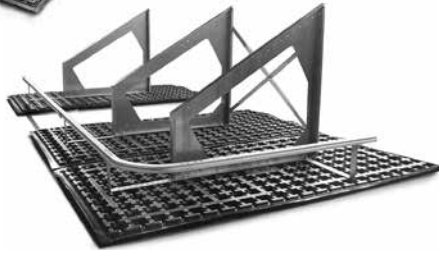

Please note that solar energy systems on roofs require servicing. Therefore, applicable accident prevention regulations must be adhered to. Fallnet® SB 200-Rail is an appropriate system component. For detailed product information please see page 36.

Solar Base SB 200

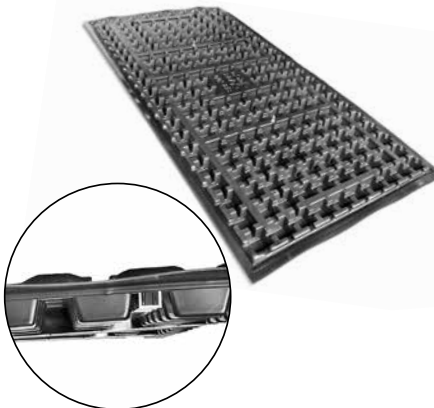

Completely pre-assembled board (made of thermoformed ABS hard plastic) with integrated aluminium profiles on the underside. Used for ZinCo Solar Base Frame SGR. Element height: ca. 43 mm; weight including reinforced profiles: ca. 7 kg; infill volume: ca. 16 l/m². Fixing material made of stainless steel. Screw thread M 10.

	Art. No.	Dimensions	Unit
Solar Base SB 200	3460	ca. 1.00 m × 2.00 m	Piece
Solar Base SB 200-Q for crosswise installation	3463	ca. 1.00 m × 2.00 m	Piece
Solar Base SB 200-4 for east-west orientation	3465	ca. 1.00 m × 2.00 m	Piece

Solar Base Frame SGR

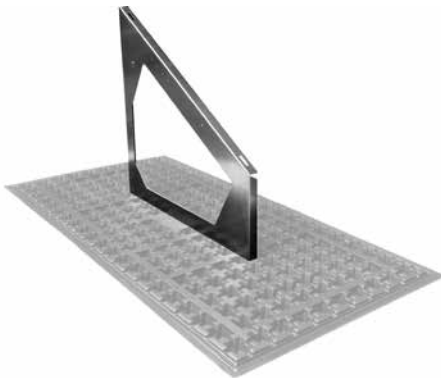

Structurally proven aluminium frame, manufactured in one piece, matches the ZinCo Solar Base SB 200. Variable use for standard exposure, east-west orientation and for height adjustment elements. Module inclinations to be chosen in 5° increments between 5° and 45°. weight: ca. 2.6 – 3.0 kg/pc; material: AlMg III; colour: natural aluminium.

	Art. No.	Inclination	Length mm	Front height mm	Rear height mm
SGR 5	970005	5°	950	350	430
SGR 10	970010	10°	950	350	520
SGR 15	970015	15°	950	350	610
SGR 20	970020	20°	950	350	700
SGR 25	970025	25°	950	350	790
SGR 30	970030	30°	950	350	900
SGR 35	970035	35°	950	350	1020
SGR 40	970040	40°	950	350	1150
SGR 45	970045	45°	950	350	1300

Further dimensions are available on request.

Photovoltaics and Green Roofs

Solar Substructure East-West

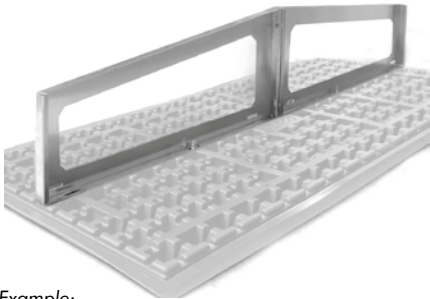

Example:

5° saddle substructure consisting of:

1 piece SB 200-4 for east-west orientation, Art. No. 3465

2 pieces SGR 5, Art. No. 970005

1 Screw Set East-West, Art. No. 9133



A pack of bolt sets is sufficient to connect 25 pairs of SGR solar base frames in the case of an east-west installation.

Screw set for the installation of the SB 200-4 and two SGR to create solar plants in an east-west orientation. Two Solar Base Frames SGR (see page 43), Art. No. 9700xx, and one Solar Base SB 200-4, Art. No. 3465, are required for each subconstruction. The assembly can be effected with the higher edges meeting in the middle („Saddle”) or with the lower edges („Butterfly”). Material: stainless steel.

	Art. No.	Unit
Screw Set East-West	9133	Pack with 50 Sets

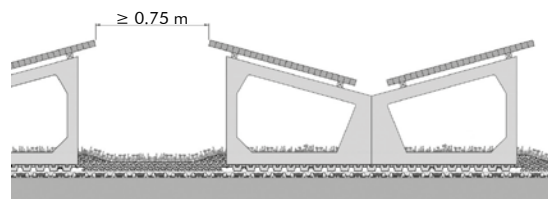

Solar Substructure Type „Butterfly”

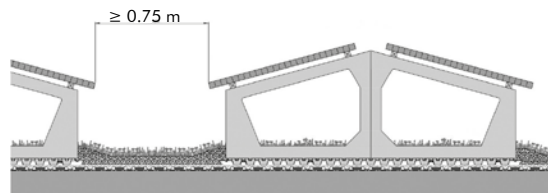

Solar Substructure Type „Saddle”

Solar Base Frame Height Adjustment SGR-HV

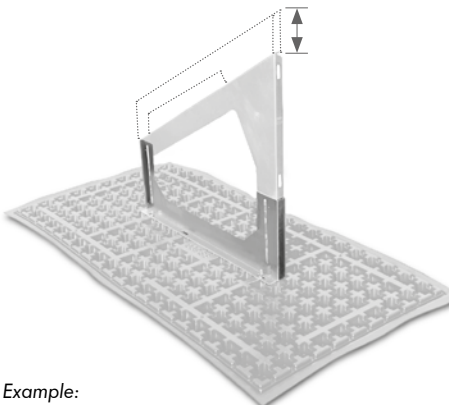

Example:

Height adjustable Solar Base Frame consisting of:

1 Piece SGR HV, Art. No. 970090

1 Piece Solar Base Frame, Art. No. 99700xx

1 Screw Set SGR HV, Art. No. 9132



SGR HV

Bottom part made of aluminium; allows for a continuous height adjustment of the Solar Base Frame of up to 210 mm. The given inclination (5° to 45°) can be adapted up to $\pm 2^\circ$. These features guarantee an optimal adaptation to changing roof slopes and the best possible alignment of the modules. Weight: ca. 1 kg/piece.

	Art. No.	Length	Front height	Rear height	Unit
SGR HV	970090	950 mm	350 mm– 560 mm	> 430 mm (depending on the slope)	Piece
Screw Set	9132				Pack with 50 Sets



Screw Set SGR-HV

A pack of bolt sets is sufficient to combine 25 solar panels SGR with one height adjustment SGR-HV each.

PV Subconstruction Accessories

Adapter Profile

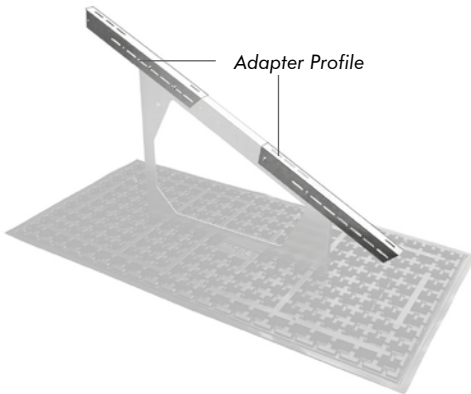

Adapter Profile made from one piece which allows for the installation of particularly large modules onto the ZinCo Solar Base Frame SGR. Secured with at least 2 screws per profile. The supporting surface for the adapter profile on the base frame must be at least 250 mm long, so the adapter profile will extend beyond this surface by a maximum of 450 mm. Two adapter profiles (one at the upper end and one at the lower end) can be used per solar base frame.

	Art. No.	Dimension	Unit
Adapter Profile	9706	L: 0.7 m	Piece

Wind Bracing

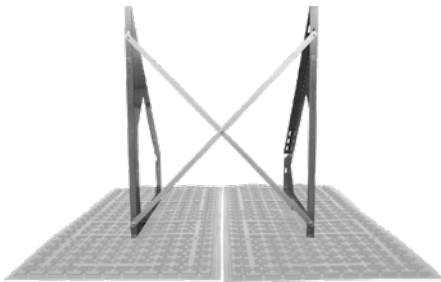

Two pre-drilled flat aluminium profiles to provide a crosswise stabilization for two solar base frames (clearance 1 m); incl. stainless steel reinforcement materials. The wind bracings for photovoltaic systems are installed with a maximum clearance of 10 m (centre to centre), and for solar thermal systems with a maximum clearance of 7 m. Due to the considerable weight of the thermal systems themselves, additional wind bracings should be installed on the front side. We will be pleased to assist you in establishing the correct position for this product.

	Art. No.	Inclination	Unit
Wind Bracing WV 5/10	971005	5° and 10°	Piece
Wind Bracing WV 15/20	971015	15° and 20°	Piece
Wind Bracing WV 25/30	971025	25° and 30°	Piece
Wind Bracing WV 35/40	971035	35° and 40°	Piece
Wind Bracing WV 45	971045	45°	Piece

Solar Mounting Profile SMP 38/33 with Accessories

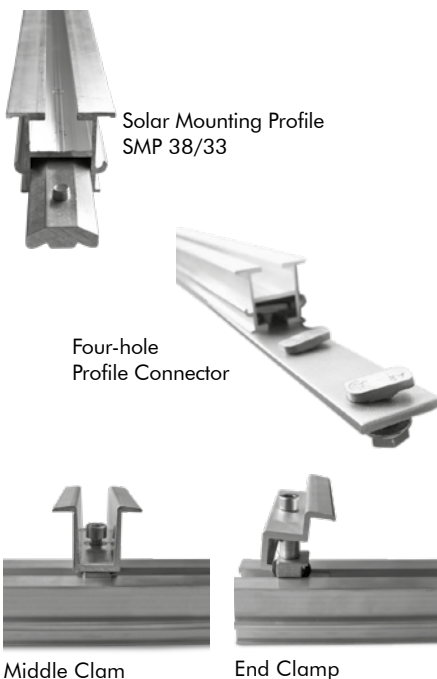

Solar Mounting Profile SMP 38/33: made of extruded aluminium, natural AlMgSi 0,5 F25; mill-finish, with profile channel both on upper and lower side. 38 mm × 33 mm (width x height), weight ca. 0.75 kg/m, including connectors and screws.

Cross connector: for coupling solar mounting profiles, including screw and threaded plate M8.

Length compensation connector: allows for thermal expansion; supplied with fasteners.

Fastening set: consisting of hammer-head bolt and locking nut.

Four-hole profile connector: to connect the joints of the SMP 38/33 Solar Mounting Profile; made of 30 × 6 mm flat material, including 4 bolts and 4 locking nuts.

Pre-assembled middle clamp: module height from 35 to 50 mm

Pre-assembled end clamp: module height from 35 to 46 mm

	Art. No.	Dimension	Unit
Solar Mounting Profile SMP 38/33	9730	L: 6.00 m; W × H: 38 mm × 33 mm	Piece
Cross Connector	9732		Piece
Length Compensation Connector	9733		Piece
Fastening Set	9734		50 pcs. per pack
Four-hole Profile Connector	9735		Piece
Middle Clamp	9736		Piece
End Clamp	9737		Piece

Why have a Green Roof?

Beyond their attractive visual nature, Green Roofs offer many undisputable benefits, both ecological and economical, provided they are built with the right system.

Improve the Microclimate

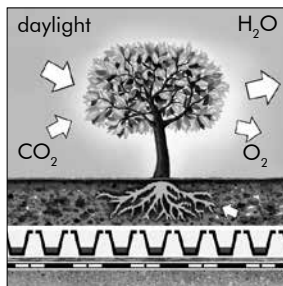

Green Roofs cool and humidify the surrounding air. Thus they contribute to improving the microclimate in urban centres. This cooling effect significantly increases the performance of air-conditioning systems, reducing carbon emissions.

Bind Dust and Toxic Particles

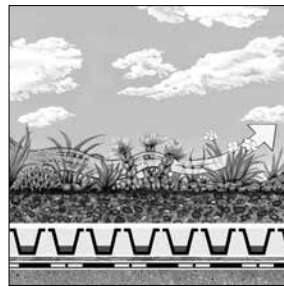

Green Roof vegetation helps to filter out dust and smog particles. Nitrates and other harmful materials are absorbed by the plants out of the air and rainfall and bound within the substrate.

Increase Rainwater Retention

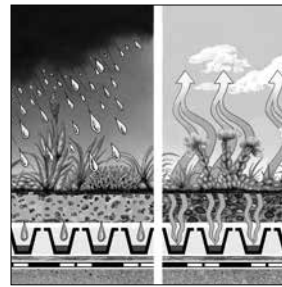

A Green Roof can reduce water run-off by 50–90%; any water flows from the roof with a delay. Outlets, pipes and drains can be reduced in capacity, thereby saving construction costs. Sewer costs can be reduced in some areas.

Improve Noise Protection

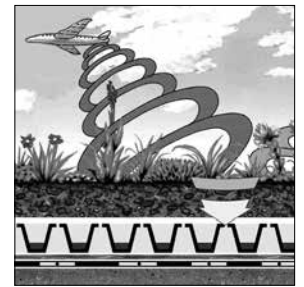

Planted areas are natural sound insulators and absorb more sound than hard surfaces. Green Roofs reduce reflective sound by up to 3 dB and improve sound insulation by up to 8 dB. This is very effective for buildings near airports, noisy nightclubs and factories.

Reduce of Energy Costs

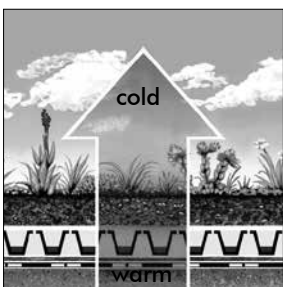

A Green Roof has the ability to buffer temperature extremes and improve the buildings energy performance.

Protect the Waterproofing

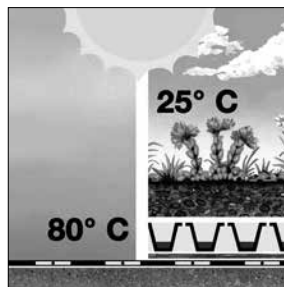

A Green Roof protects the waterproofing from climate extremes, UV exposure and mechanical damage. This greatly increases the life expectancy of the waterproofing and results in reduced maintenance and replacement costs.

Offer a Natural Habitat

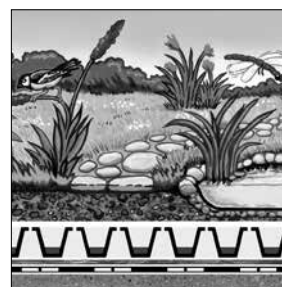

Landscaped roofs compensate for green spaces, which are lost to building development. They provide natural habitats for wildlife and bring nature back into the cities.

Provide Additional Space

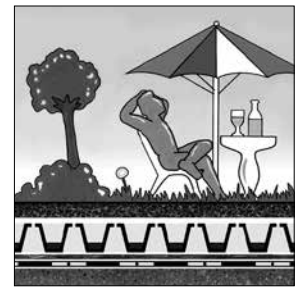

Green Roofs offer additional space for numerous uses. Whether you want a relaxing garden, a playground or a golf course, it all can be achieved as part of the existing footprint.

Types of Green Roofs



Extensive Green Roof

There are two basic types of Green Roofs with a number of variations. Extensive landscaped roofs are an ecological alternative to conventional surface protection or ballast layers such as gravel and pavers. They are lightweight and have a shallow Build-up height. Suitable plants include various Sedum species, herbs and some grasses.

The aim is, that these systems can cope with the conditions on the roof (sun, wind, drought, etc.) by nature. After establishment of the vegetation, the maintenance is limited to one or two inspections a year.

Extensive Green Roofs

- **minimal maintenance required**
 - inspection 1–2 × / year
 - supply of water and nutrients usually by natural processes
- **adapted plant communities**
 - undemanding, drought-tolerant
 - self-regenerating
- **little weight and shallow build-up height**
 - mainly mineral substrate with depth up to 120 mm
 - weight approx. 50–150 kg/m²
- ➔ **surface protection with ecological functions**

Intensive Green Roofs

- **regular maintenance required**
 - garden maintenance such as mowing, fertilizing, watering, weeding etc.
- **weight and build-up height depending on plant selection**
 - e. g. ornamental lawn, summer flowers, demanding shrubs, bushes and trees
 - substrate with higher amount of organic material, with depth > 150 mm
 - weight > 150 kg/m²
- ➔ **well kept Roof Garden**



Intensive Green Roof

Intensive Green Roofs can most easily be compared to building a garden on a roof. They are usually multifunctional and accessible. They require more weight and a deeper System Build-up. The maintenance is regular and depends on

the landscape design and the chosen plant material. Depending on the substrate depth, anything is possible from lawns, perennials, shrubs, trees including other landscape options such as ponds, pergolas and patios.



ZinCo Green Roofing Systems now with European Technical Assessment!

In 2013 ZinCo received European Technical Approval ETA with the number 13/0668 for a wide range of proven green roof systems. Since June 2018, the European Technical Approval has been replaced by the European Technical Assessment.

On the one hand, this is a prerequisite for unrestricted access to the European

market and its contracting states and, on the other hand, it reassures architects, contractors and owners that the relevant systems and products have passed the mandatory proof procedures and are in accordance with the assessment requirements.



The following System Build-up versions have a European Technical Assessment:

	Extensive green roof "Sedum Carpet"	Extensive green roof "Rockery Type Plants"	Simple intensive green roof "Heather with Lavender"	Intensive green roof "Roof Garden"
Root Barrier (optional)	(Root Barrier WSB 100-PO)	(Root Barrier WSB 100-PO)	(Root Barrier WSB 100-PO)	(Root Barrier WSB 100-PO)
Protection Mat	Protection Mat TSM 32 / Protection Mat SSM 45	Protection Mat TSM 32 Protection Mat SSM 45	Protection Mat SSM 45	Protection Mat ISM 50
Drainage Element	Floradrain® FD 25-E Fixodrain® XD 20	Floradrain® FD 25-E	Floradrain® FD 40-E	Floradrain® FD 60 neo
Filter sheet	Filter Sheet SF	Filter Sheet SF	Filter Sheet SF	Filter Sheet SF
Substrate layer	System Substrate Sedum Carpet	System Substrate Rockery Type Plants	System Substrate Heather with Lavender	System Substrate Lawn, System Substrate Roof Garden

The number of European-approved products and systems will be expanded gradually.

The Roofs of the Future are Green

Roofs are more than just “functional components” for the protection of the building structure. Roofs give character to individual buildings and entire city districts.

Beyond that, roofs are more and more considered as open resource areas. They attract urban planners looking for socially responsible concepts that counteract the loss of natural living space and provide solutions for problems such as stormwater management and urban heat island effect in densely populated cities.

Green Roofs are extending the formal language of contemporary architecture and confer a new significance and value on the concept of “Roof Landscape”: Nature – increasingly ousted by buildings and paved surfaces – returns as an attractive green element in residential, recreational and working environments.



Important soil functions such as water transport are being lost due to ground sealing in towns and cities. Stormwater is less able to seep into the surface, therefore increasing the flood risk in the event of heavy rainfall.

Ongoing soil sealing has the additional effect, at the same time, of further heating up inner cities in the summer. The reason is that evaporation, which contributes to air cooling cannot take place from sealed surfaces.

A green roof can help here by retaining water, providing moisture for the air and creating a new habitat for plants, animals and people.

What ZinCo can do for you

ZinCo provide a comprehensive package of environmentally sound Green Roof Systems and customized project support, based on:

- 45+ years of experience in Green Roofs
- Tested & proven Green Roof Systems
- Exceeding quality standards & permanent innovation through research and development
- Compliance with relevant international standards
- Experts in structural engineering, landscape architecture, horticulture, material and soil science, ...
- Support from planning to completion (design, specifications, CAD, consultancy, on-site)
- An international network of partners
- Comprehensive warranties

To date, ZinCo Green Roof solutions have inspired planners and contractors throughout the world, providing them with the necessary flexibility to accommodate a wide range of designs and building needs.

Tell us about your project!
We've got the expertise to bring it to life.



**System Build-ups with
European Technical Assessment
(Details on page 48)**



ZinCo Green Roof Systems Ltd.
Wittas House, 2 Rivers Industrial Estate, Station Lane,
Witney, OX28 4BH · United Kingdom
Phone: +44 (0) 1993 229700 · Fax: +44 (0) 2031 631915
office@zinco-greenroof.co.uk · www.zinco-greenroof.co.uk