



PLANNING GUIDE

Elefeet® System Solutions for Raised Paving and Decking

Life on Roofs





More Possibilities with ZinCo

Technical Principles 3



General Information on Walkways on Roofs 4



Paving Slabs on Elefeet® Pedestals 5
Elefeet® pedestals and Accessories 7



The Elefeet® Support Rail System 8
Accessories for the Elefeet® Support Rail System 10





Elefeet® Rail System for Wood Decking 11



Technical Principles

At a progressing rate, roofs are being used holistically and now almost everything which can be realised on ground, is possible on roofs as well.

To create long lasting and functioning walkways and driveways on roofs it is crucial to use the right technique. This planning guide will provide essential information.

Symbol	Force	Load	Additional Forces
	Category H Single person, maintenance and servicing on green roofs, e.g. roof gardener, chimney sweeper	total load 1.0 kN (at a critical point)	EN 1991-1-1:2002
	Category Z Residential Buildings	total load 4.0 kN/m ² single load 2.0 kN/m ²	



Drainage

In contrast to the run-off delay or retention of stormwater that occurs on green roofs water must be discharged almost completely from walkway and driveway areas on and below the surface. While the surface water on raised paving and decking will flow off immediately through the open joints, a grill should still be used over the roof outlet.

The water run-off coefficient for paved surfaces varies from $C = 0.8$ to 1.0 ; drains must be planned so that they allow for drainage on two levels: from the drainage level and from the surface area.

Inclination

The BS 6229 & BS 8217 standards require a minimum slope of 1:40 when designing a flat roof, with the aim of draining surface waters as quickly as possible. However, there may be structural requirements where roofs need to be designed with less slope or even as 0° roofs. In these cases the quality of the waterproofing is even more important.

Raised paving and decking do not need any slope since water can drain through the joints. Nonetheless, we recommend installing the raised surface at a slight slope to prevent ponding, in particular in the case of large slabs.

In addition, the waterproof membrane should be at a slight slope to prevent ponding and possible odour pollution.

In general, when designing a fall the connection heights need to be taken into consideration. If possible, surfaces should not allow water to drain towards the building structure. Therefore, these considerations should be incorporated early in the planning stage.

For additional technical and other information, please see the brochure issued by the Landscape Research and Development Society (FLL e.V.)



General Information on Walkways on Roofs

Installation on a chipping base

Slabs are laid loosely on the chippings. In order to prevent any movement, there must be a stable edging all round. Slabs installed on a chipping base are generally recommended where a combination of greenery and walkway is required or where the load-bearing capacity is sufficient.

Pavers with a thickness of at least 4 cm should be used because thinner pavers are not ideal for installation on chippings. They have a lower mass and will therefore break quicker. They are also difficult to tap or vibrate when they are being laid.



Installation on pedestals

Paving on pedestals is also laid loosely and requires a stable edging all round. The accessories, however, cannot replace a stable edging. Pedestals are used where the roof area does not have sufficient load-bearing capacity. After

installation, the only load on the structure is that of the paving. Due to their low weight, the pedestals themselves can be disregarded. In addition, cables or any type of pipe can be run beneath the flooring without a problem.



Installation on pedestals and rail

With the rail system on pedestals, edge retainers can be used for the paving edging. You don't need additional edging here but can create open edges or surfaces, for example, that run up to extensive green roofing and are only separated by a strip of gravel. Due to the stability and effective load distribution,

the larger span widths are easily managed, and not as many pedestals are required. Using spacers, the substructure is designed as a kind of coherent surface which allows for hardly any movement in the paving. The support plates that are flexible and space-saving provide for the creation of almost any joint pattern.



Possible types of flooring

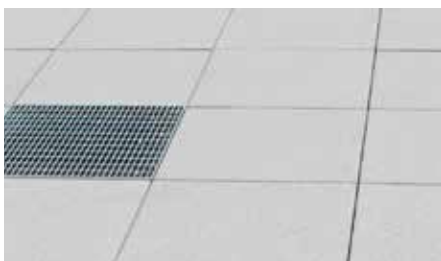

Concrete pavers

Concrete pavers on Elefeet® pedestals can be naturally and easily combined with different elements, e.g. grids.



Ceramic tiles

Areas with ceramic tiles can also be installed on Elefeet® pedestals if the edging is stable, or on rails, provided the edging is suitable.



Wood decking

In combination with the Elefeet® Support Rail System, wood decking can be laid to be stable, and also laid over large areas.



Paving Slabs on Elefeet® Pedestals

Elefeet® pedestals are made of stable rot-and frost-resistant polypropylene. They are specially suited for use beneath walkways with concrete or natural stone pavers with an all-round stable edging, and they have a load-bearing capacity

of up to 600 kg per pedestal as per load class Z in accordance with EN 1991-1-1 (balconies, roof terraces, loggias). As they are infinitely height-adjustable, any unevenness can be easily levelled out, and they are perfect for gradient-free

surfaces, so that the paving is installed on "dry feet". Their integrated 3 mm joint spacers ensure a visually uniform joint pattern across the entire flooring.

From approx. 70 mm
to approx. 500 mm

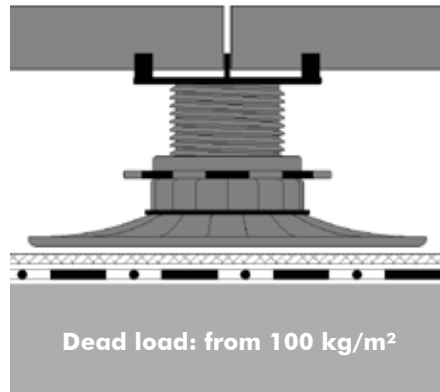

Slabs of e.g. concrete or natural stone, or ceramic or wood decking*

ZinCo Elefeet®
(available in various heights)

Elastosave ES 30
separation layer if required e.g.
Slip Sheet TGF 20

Roof construction with waterproofing

*Material thickness usually concrete > 40 mm,
ceramic tiles > 20 mm, if approved by the
manufacturer, less thickness is sometimes possible.



Elefeet® E 106
adjustable from 106–196 mm



Elefeet® E 60
adjustable from 60–106 mm



Elefeet® E 38
adjustable from 38–60 mm



Elefeet® E 27
adjustable from 27–39 mm



The Installation on Elefeet® pedestals offers a number of important advantages:

- Precise levelling with vertical adjustment swivel including reverse rotation protection
- Very low weight – only the surface layer needs to be considered
- Simple to install due to easy to-handle materials and high flexibility
- No transport problems (gravel, mortar) to and at the installation site
- Spring-loaded detent nose warns against unscrewing too far
- Open joints, free from pollution and weeds
- Firm support for cut-to-size slabs in the edge area
- Load bearing capacity up to 600 kg/pc
- Safe drainage of paving/decking and roof
- Usable on roofs without any slope due to large drainage cavity
- Excellent aeration of paving and decking
- Hollow space usable for the installation of all types of cables



The oval shape of the new Elefeet® base plate enables the pedestal to be placed right at the roof edge and, once a cut has been made along the pre-defined line, even directly in the corners.



Given the slight pre-stressing already applied to the base plate during manufacture, solid support without wobbling is ensured right from the start. As a result, the pedestals are also stable and secure when the flooring and the additional weight are applied.



Of course, different types of flooring can be easily combined, e.g. grids and concrete pavers.

Elefeet® Pedestals and Accessories



Given the Elefeet® A 12, A 22 and A 67 extension pieces that allow for multi combinations and securely lock into place, a stable overall build-up height up to approx. 500 mm is possible.



The new adjusting tool allows for the easy and subsequent adjustment and accurate setting of the required height, even after the pavers have been laid.



The buffer pad tailored to fit the head of the Elefeet® ensures a non-slip grip and is ideally suited as a base for thin-layered ceramic tiles.



In the edge areas, the practical edge retainers ensure a stable position of the pavers without them wobbling. Thanks to the recesses in the edge retainers, the joint spacers on the support plate continue to ensure a uniform joint pattern here too.



The Cantilever Arm Support allows for close connection to doors or insulating fillets. The doorstep height can be reduced to a minimum of 50 mm, if a drainage channel is used in front.



For example, if an installation is not to be at 90° to the laying direction of the pavers, the mitre cut support can be used. This will allow for precise installation including firm support at the edge.





High Loads and Complex Roofscapes - the Elefeet® Support Rail System

The Elefeet® Support Rail System allows for the easy construction of a safe and stable sub-structure that is perfectly suited for surfaces without a firm edging.

Whether the flooring is made of concrete, thin-layered ceramic tiles or wood: The combination of Elefeet® pedestals with the Elefeet® Support Rail System can be used for virtually any construction challenge. The extensive and perfectly tailored range of accessories in the complete Elefeet® system can be used for almost every geometry, even in the case of high loads.



Advantages of the support rail system in combination with the Elefeet® pedestals:

- Less pedestals are required to achieve the same loadbearing capacity
- Laying the actual paving slabs and decks is much faster
- By interconnecting all components the substructure ensures stability during installation and operation
- Ideal substructure for thin-layer ceramic tiles
- Light and weather-resistant substructure for wooden decks
- Substructure can be used several times (e.g. if the wooden deck needs to be replaced)
- Simple and flexible accessories allow for a stable edging in the case of flooring with pavers
- Simple and quick alignment along the entire length of the rail (the first and the last pedestals are installed first and the remaining pedestals only after levelling)

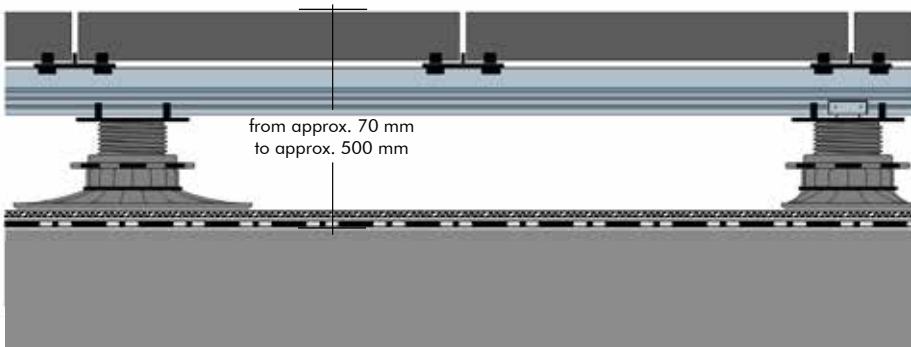

Slabs of e.g. concrete or natural stone, or ceramic or wood decking*

Elefeet® Support Rail with Support Plate

ZinCo Elefeet® (available in various heights) with fixing clamp

Elastosave ES 30 separation layer if required e.g. Slip Sheet TGF 20

Roof construction with waterproofing

*Material thickness usually concrete > 40 mm, ceramic tiles > 20 mm, if approved by the manufacturer, less thickness is sometimes possible.



Prepared for Everything with Stability - The ZinCo Elefeet® Support Rail System



The quick-fix rail support clip allows the rail to be easily clipped into the head plate of the Elefeet® Pedestals.

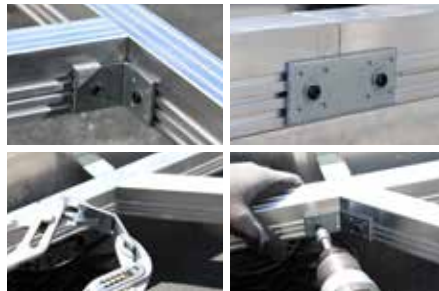

The various rail connectors allow for easy and stable assembly of the overall sub-structure.



Steps, ledges and other obstacles are easy to construct with the "rail connector high/low rail".



The "variable distance holder" adapts to any desired surface format and provides a stable substructure with constant dimensions.



The two "edge holders" ensure stability right up to the edge. These are available in two designs, one to be screwed to the side of the rail the other to be fixed at the head end of the rail.

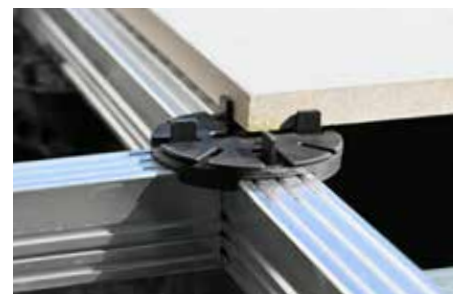

Tightly screwed to the rail system, the "support plate" with integrated joint spacer ensures that the laid pavers or tiles are kept from sliding.

Elefeet® Support Rail System – the Permanent Substructure for Wood Decking

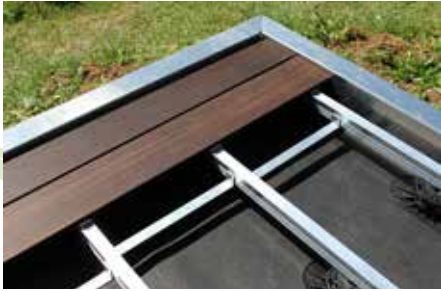

The new Elefeet® Rail Support System, together with the Elefeet® pedestals, provides the perfect substructure for wood or WPC decking.



We supply the required fixing elements for wood or WPC decking together with the rest of the order.



Generally, the fixing elements can be easily screwed into the rails and are invisible.



Given the flexibility of the rail system, it is easy to deal with the required decking lengths, in order to retain a stable butt joint for the decking elements.



The wood decking can be easily and quickly fixed to the rail system with little effort.



The transition between different types of walkway are easy to execute with Elefeet® pedestals and the Elefeet® Support Rail System, and are stable and sustainable.



Flexible, when it matters, because what is important is what is beneath the surface!

This system brochure provides a general overview of solutions for raised paving and decking.

Our technical experts will be pleased to advise you on specific solutions for your own individual building projects: from the planning phase right through to creating your specification texts.

Challenge us!



ZinCo Green Roof Systems Ltd.
F26, Elmfield House · New Yatt Road · Witney, OX28 1PB · United Kingdom
Phone: +44 (0) 1993 229700 · office@zinco-greenroof.co.uk · www.zinco-greenroof.co.uk